



2025 Catalogue



The History of Access Irrigation

Access was started in 1958 by Mr Graham Pearce, an industrial chemist who had traded chemistry for the 'good life' running a small market garden in Crick, Northamptonshire. To try and get a better price for his strawberries, he designed an innovative glass and steel cold frame with sliding glass sides for easy access – hence our name Access.



Original cold frames at Crick



Original drip nozzle

The sandy soil at Crick caused low strawberry yields and it was decided to concentrate instead on selling the cold frame. Before the invention of the polytunnel, cold frames were a low cost way of growing under glass. As nurseries and growers began to take up the cold frames with enthusiasm, attention was turned to providing irrigation inside the frames. Unhappy with the nozzles already available, Mr Pearce used his scientific background to design his own.

The invention of the polythene tunnel caused the company to refocus. Cold frames were then targeted at the keen gardener and the irrigation division was formed to supply growers with irrigation – still in its infancy in the UK.

From its horticultural roots, the irrigation division of Access focuses on 3 main areas: horticulture, landscape and more recently green systems including green roofs. All systems are designed to the same exacting standards of efficiency and durability as our horticultural irrigation systems.



Our premises on the original site

In 2001 the company launched its highly respected components catalogue, coupling professional quality components with helpful tips and advice.



Green roof system

The Access philosophy, instilled by Mr Pearce in the 1960's, has always been to provide innovative products coupled with good customer service. From advice to supply, Access are able to offer a fast, friendly service backed up by our own specialist design function and dedicated warehouse.

We are here to help.

Request our Irrigation Guides

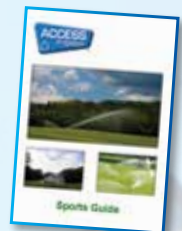



Welcome to our 2025 catalogue

Welcome to our latest catalogue, filled with professional quality irrigation components.

Order ONLINE

Our new website allows you to browse and purchase our entire product range quickly and easily. You can also download relevant PDF information sheets. Items with this logo have bulk pricing online.



FREE Economy Delivery

For not so urgent orders we can offer a FREE delivery service on orders over £125 in value*.

STANDARD Delivery

We deliver fast, as standard, using fully traceable carriers. For landscapers we can even deliver direct to the clients address, allowing work to start as soon as the goods arrive.

NEXT DAY Delivery

For really urgent orders, we also offer a next day service for items in stock. If necessary, items can be put on an AM delivery*.

COMPETITIVE Pricing

Access offer quality irrigation components at competitive prices, so you can always be sure of a good deal – and all backed up by our friendly and knowledgeable sales team!

We look forward to assisting you.



Mike Briley
Sales Director

mike@access-irrigation.co.uk
01788 220 400



Marketa Ouchouche
Irrigation Sales Advisor

marketa@access-irrigation.co.uk
01788 229 915



Matthew Pearce
Director

matthew@access-irrigation.co.uk
01788 220 403



Eileen Inley

Accounts / Despatch
eileen@access-irrigation.co.uk
01788 220 402



Josh Thornton

Irrigation Sales Advisor
josh@access-irrigation.co.uk
01788 229 901

Liquid Feeding 2

Nursery 3

Mist Propagation 8

Sprinklers 10

Hand Watering 14

Landscape 18

Control Systems 28

Pumps 32

Pipe & Fittings 37

Sports 48

Order Information 52

Index 53

* For more information on our free delivery, standard despatch and same day despatch services, see page 52.

Liquid Feeding

A pressure regulator must be fitted to all systems capable of delivering above the rated pressure. For fertilisers Water Regulations require a double check valve (see p45) in domestic situations or a pump and tank set for commercial use to prevent back-contamination.

Static Dilutors



Don't leave partially used feed overnight.



Fill the Static Dilutor bottle with liquid feed, select the appropriate jet and connect to the water supply. As water passes through the dilutor head it draws up a ratio of liquid feed which mixes with the water. Designed to be filled, put near the tap, and then not moved until it is emptied. **Max operating pressure 2.5 bar.**

Capacity	Flow Rate		Connector Type	Jets Supplied	Code	Price £
	min	max				
9.0L 2 gal	0.3m ³ /h 60 gph	2.3m ³ /h 500 gph	Brass quick connector & 'Geka'	10:1	ADS (normal flow)	79.00
				25:1		
				50:1		
				100:1		

Mobile Dilutor



The Mobile Dilutor gives extra versatility. The liquid feed is kept inside an inner bag. This has a number of advantages, the unit need only be part filled, it can be moved from tap to tap without disturbing the final dilution rate and it can be left part-filled overnight.

A wider range of chemicals including those of a similar density to water can be used.

The bottle will withstand 4.0 bar pressure and is manufactured from heavy duty polythene.

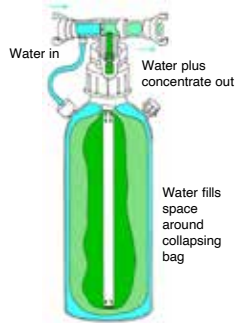

ADMP

Capacity: 6.5L/1.4 gal. 'Geka' type connections are supplied as standard.

Pressure	Flow Rate		Jets Supplied	Code	Price £
	min	max			
4.0 bar	0.3m ³ /h 60 gph	3.4m ³ /h 750 gph	100:1 150:1 200:1	ADMP	249.00
Snap connector conversion kit - allows Hazelock type fittings				ADM-FQC	17.00

The ideal Dilutor where greater sophistication is useful.

Dilutor Spares

	ADS	Price £	ADMP	Price £
Replacement Bottle *	ADS-BTL	30.00	ADMP-BTL	165.00
Replacement Head and boss *	ADS-HBA	38.00		
1 downtube and jet pack * (ADM jet pack only)	ADS-JTP	7.50	ADM-JP	4.50
Replacement head assembly			ADM-HDA	38.00
Replacement boss and stem			ADMP-BSA	41.00
Replacement inner bag *			ADM-BAG	14.00
Pressure regulator kit with Gekas (all models) *	AD-PR	44.00	* compatible with post 2005 units	



AD-PR pressure regulator

Nursery

5% off if you order 3 or more kits

Also supplied: straining wire, wire strainer, suspension straps and glue

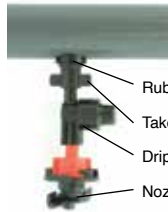
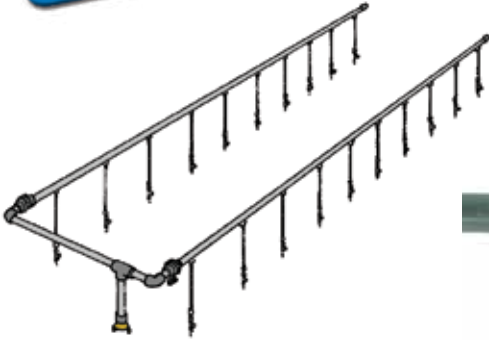

Glasshouses

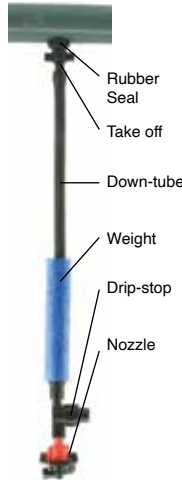

Tunnels

The Access Mini-spin nozzle gives a very even level of distribution.

The bridge-less design has a rotating anvil which shatters the water into evenly spread particles. In comparison, the tiniest blemish or build up of lime on a fixed anvil nozzle gives permanently uneven distribution.

The nozzle fits at the end of a flexible dropper tube. In low tunnels the pipe lines can be above head height, yet allow the nozzle to remain at a height to ensure the best distribution pattern without "bounce back". Drip-stop valves are fitted to each nozzle. **Glue included.**

Remember, these are complete kits!

All designs give high uniformity

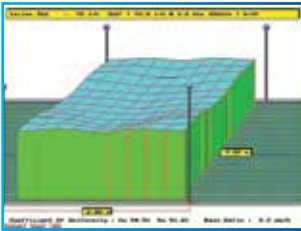

When ordering - quote code and length required, e.g. KU3-10

Multi-span Houses Lines can be linked together to a header pipe, with valves or solenoid valves to each line. Contact our sales team.

Spray line length	Tunnel width Price £							Glasshouse width Price £		
	KU3	KU4	KU5	KU6	KU8	KU9	KW4	KW6	KW9	
m	ft	3.0m 10'	4.2m 14'	5.5m 18'	6.4m+7.3m 21'+24'	8.2m 27'	9.1m 30'	4.5m 15'	6.1m 20'	9m 30'
10	33	127.00	127.00	260.00	260.00	269.00	269.00	117.00	250.00	260.00
14	46	149.00	149.00	349.00	349.00	359.00	359.00	139.00	338.00	348.00
16	52	159.00	161.00	371.00	371.00	381.00	381.00	151.00	357.00	367.00
18	59	171.00	171.00	395.00	395.00	404.00	404.00	162.00	386.00	396.00
20	66	184.00	184.00	418.00	418.00	428.00	428.00	177.00	412.00	423.00
24	79	220.00	220.00	477.00	477.00	487.00	487.00	204.00	472.00	482.00
26	85	266.00	264.00	534.00	534.00	544.00	544.00	239.00	525.00	535.00
30	98	283.00	283.00	605.00	605.00	615.00	615.00	281.00	572.00	582.00
Water used per 2.0m run		70 l/h	160 l/h	140 l/h	210 l/h	240 l/h	320 l/h	160 l/h	210 l/h	320 l/h
Lines		1	2	2	2	2	2	1	2	2

Supplied with 2.5m lengths of pre-drilled and socketed uPVC pipe, Access Mini-spin nozzles, drip-stop valves, downtubes (tunnels only). Entry 'Geka' hose fitting. Twin lines (3.0m/4.2m/4.5m widths are single line) include linkage pipework and on/off valves to each line. **Fixings supplied:** Wire strainers, straining wire and suspension straps (single line in tunnel has suspension straps to fix to ridge)

For 'Geka' hose tails see p15; Blanking plugs or shut off valves to blank off nozzles see p38

CNL Drippers



These 'state-of-the-art' drippers are designed for crops such as Strawberries where extremely high uniformity is required. The pressure compensated drippers also have a non-leakage device which 'locks' the dripper at the end of the cycle, preventing water drainage at the end of the cycle and the need to refill at the start of the next cycle.

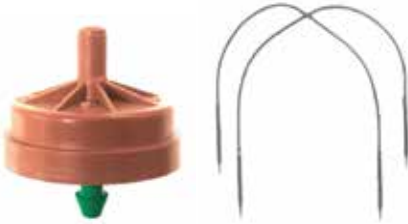

	HCNL	LCNL
Pressure Range:	1.4 - 4.0 bar	1.0 - 4.0 bar
Max head sustained	0.3 bar	0.15 bar
4 way manifold:	80cm black leads, 'S' stakes	

Dripper only		Pack of 25	
Output	Type	Code	Price £
4 l/h	LCNL	D4N-Q	22.00
6 l/h	HCNL	D6N-Q	22.00
8.5 l/h	LCNL	D8N-Q	22.00
4-way manifold		D8N4L-Q	62.00
Single outlet		DNEA-Q	11.00

Netafim PCJ CNL Drippers

- Labyrinth design with maximum filtration area
- Continuously self cleaning dripper
- Silicon injection moulded diaphragm

Drippers are available in two operating pressures, with the HCNL having a higher shut off pressure, making them better suited to sloping sites.

Available as dripper only, or with 50cm or 80cm lead and Prevo 'S' stake.

LCNL operating pressure: 0.7 - 4.0 bar

HCNL operating pressure: 1.5 - 4.0 bar



Single dripper

Dripper with 80cm lead

Dripper only		Pack of 25		Pack of 100	
Output	Type	Code	Price £	Code	Price £
1.2 l/h	HCNL	D1PCH-Q	9.90	D1PCH-H	38.00
2 l/h	HCNL	D2PCH-Q	9.60	D2PCH-H	32.00
2 l/h	LCNL	D2PCJ-Q	6.50	D2PCJ-H	24.00

Dripper & Lead			Pack of 25		Pack of 100	
Output	Type	Length	Code	Price £	Code	Price £
1.2 l/h	HCNL	50cm	D1CNHA-Q	16.00	D1CNHA-H	51.00
2 l/h	HCNL	50cm	D2CNHA-Q	16.00	D2CNHA-H	51.00
2 l/h	LCNL	80cm	D2CNJA-Q	16.00	D2CNJA-H	52.00

Dripper with Shut Off



Ideal where individual drippers need to be shut off. The dripper can either rest on the compost, or can be staked. Pressure Compensated CNL nozzle. Pre-assembled 2 l/h dripper, lead, nipple, cap.



	Qty	Code	Price £
Dripper/Lead/Cap	25	D2ENPA-Q	27.00
	100	D2ENPA-H	102.00
Stake	25	DAP-Q	6.70
	100	DAP-H	25.00

Punches



Description	3mm	Price £
Budget Hand Punch	DPB3	7.50
Punch pliers 16/20mm	DPP3	22.00
Punch pliers 25/32mm	DPPL3	23.00

Flexidrip Nozzles with Stake



Nozzle with stake. 2 l/h @ 1 bar.
Needs leads.

The Access Flexidrip nozzle is joined to its stake with a unique 4-way universal joint, providing a strong, snag-free unit.

Qty	Code	Price £
25	D2NSL-Q	13.00
100	D2NSL-H	51.00
500	D2NSL-5H	239.00

Dripper Leads



5.0mm x 80cm leads can be cut to provide shorter lengths.
Use DNIP adaptor to connect to lateral pipe.



Length	Qty	Code	Price £
80cm	25	DL80-Q	6.20
80cm	100	DL80-H	23.00
	25	DNIP-Q	4.10
	100	DNIP-H	14.00

Ottima PC360

Compensated dripper – ideal for larger pots

The Ottima PC360 is a pressure compensated dripper making it ideal for larger pots and planters where more water is required. The Ottima sprays over a wider diameter than a traditional dripper, reducing water run-through on hanging baskets.

Watered area approx. 0.25m diameter.

Flow: 30 l/h. Pressure: 1.5 - 3.0 bar.

Connect onto a 16mm or 20mm supply pipe using small bore pipe – use P13-20M – see p27.

Requires 3mm punch – see p4; for a barbed connector into 16mm or 20mm pipe use DNIP - see above.



Qty	Code	Price £
10	DOF30-T	12.00
100	DOF30-H	105.00

Tree Watering Dripper



- 8 l/h output for faster watering
- Simply punch dripper into 20mm pipe
- Pressure compensated

Netafim 8 l/h CNL dripper for precise, pressure compensated watering. Simply run a 20mm polythene pipe above the tree pots and punch in the dripper and fit the lead and anchorage stake.

Qty	Code	Price £
25	D8TD-Q	46.00
100	D8TD-H	177.00

Stock Bed Watering

This low cost watering system is ideal for watering large areas economically. Each stake set includes a riser pipe, fittings, sprinkler and straps to fit to the customers own stake (25mm square is ideal).

The medium kit will water an area up to 100m² (25m x 4m). Requires 3mm punch.

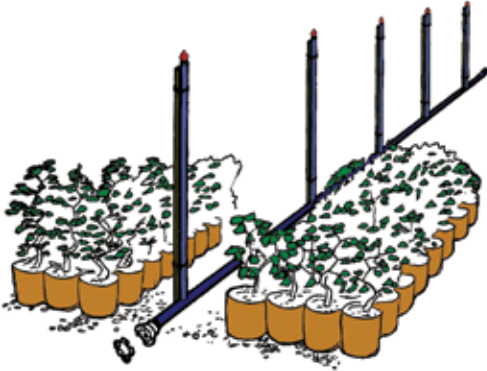

What you get:

- 10 risers 1.2m high
- Sprinklers (3 sets in medium kit)
- 50m of 20mm pipe
- Fittings for end or centre feed
- 'Geka' entry connector

For small bed kits see p18.

Covers up to 120m²

Code	Price £
SKDC	130.00

Nozzles	KE070	KES070	KES120
Bed width	2m	3m	4m
Max length	18m	25m	30m

T-tape

One of the most popular drip tapes available in the UK, T-tape is ideal for larger scale field crops.

DATA SHEET ONLINE

Tape Marking	Wall thickness	Dripper spacing	Output l/h per 100m	Reel Length	Code ~	Price £
TSX 506	150 micron	20cm	250 l/h	3048m	TT06-250	320.00
		20cm	500 l/h	3048m	TT06-500	330.00
TSX 510	250 micron	20cm	500 l/h	1829m	TT10-500	290.00

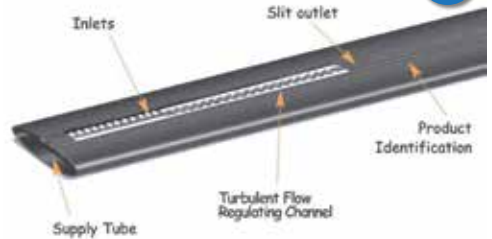

Fittings:	Code	Price £
¾" BSPM	TTK16-3	0.70
16mm poly pipe	TTK16-16	0.60
Joiner	TT16J	0.50

Ring to check availability



TT16J



TTK16-3



TTK16-16



~ see p52

T-tape for Glasshouses

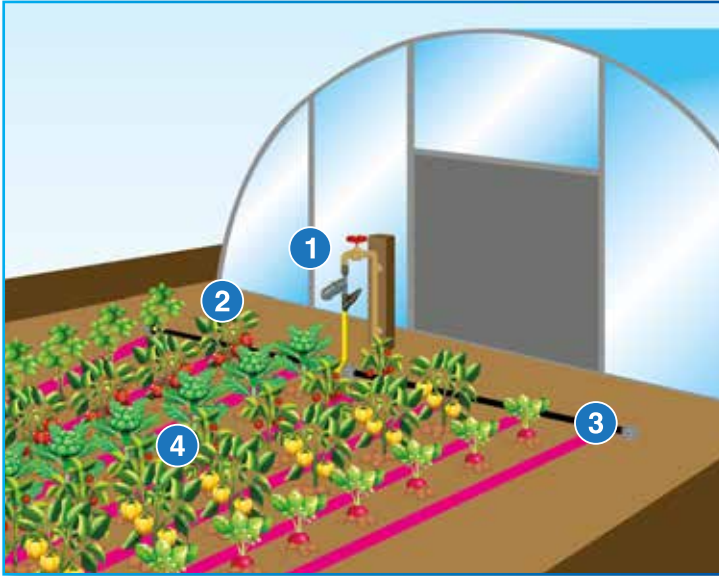

Designed for row crops in tunnels each dripper is just 20cm apart. This low cost, thin wall system is ideal for flower crops and vegetable production.

Select the parts you need in 4 easy steps:

- 1** Buy one starter pack per system.
- 2** Buy one header pack per bed. Add up the width of all the beds – you will need this much 16mm header pipe.
- 3** Total up how many runs you will have – you will need one entry fitting per row
- 4** Multiply the number or rows you have by their length to give the total meterage of T-tape you need.

Output @ 0.55 bar	5 l/m/h	Line spacing	0.3–0.45m or one per row
Operating Pres.	0.3 - 0.9 bar	Capillary beds	0.6m
Maximum length on 0% slope:	50m		

Pipe Headers

- 1 Starter pack**
Contains filter, pressure regulator and punch. Includes both 'geka' and snap connectors. Can be fitted to the outlet of a 1/2" tap (this has a 3/4" thread) or can be put in the hose line. Includes a budget hand pump.
- 2 Header pack**
Contains fittings to create a centre fed header, with 'geka' and snap connectors (p17). Does not include header pipe – use 16mm pipe. This will allow up to 400m of T-Tape to be used per bed.

Entry Fittings

- 3** One entry fitting required per run. Requires 4mm hole to be punched into the side wall of the header pipe.



T-tape for Glasshouses



- 4** 16mm T-tape with 20cm dripper spacing.

Reel Size	Wall Thickness	Code	Price £
375m	250 micron	TT10-500-S	150.00
675m	150 micron	TT06-500-S	150.00

Description	Code	Price £
Starter Pack	LHPSP	97.00
Header Pack	LHPC16	13.00
16mm x 25m header pipe	PA16-25M	21.00

Qty	Code	Price £
10	TTE16-T	6.80
100	TTE16-H	58.00

Punch



	4mm	Code	Price £
Budget Hand Punch		DPB4	8.40
Punch Pliers 16/20mm		DPP4	13.00

Mist Propagation

Mist propagation produces high success rates, even with difficult specimens. Also provide bottom heat – cool tops and warm bottoms produce the best results!



Mist Wean Controller



- Extremely Reliable Controller
- Wean function built-in
- Easy to programme

The controller features 3 easy to use dials. The 'valve on' dial allows the burst length to be set. The 'delay' dial can either be set to 'off', in which case the mist will burst every time the wet leaf dries out, or it can be set to a minimum delay to allow for weaning. Finally the 'sensitivity' dial adjusts the sensitivity of the wet leaf.

Complete with 2.5m wet leaf, mains plug and cable and solenoid cable.

Code	Price £
MAMWCL	309.00

Polyphosphate filter available for hard water areas (page 9)

For larger units, Heron panels with multiple wet leaf interfaces are available. Contact our Sales Department.

Overhead Kit - Single Bench



Twin Bench kits available

Riser Kit - Single Bench

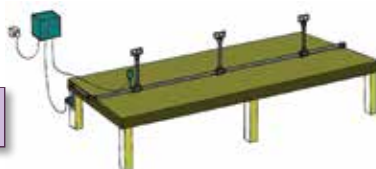

With Mist Controller, wet leaf, solenoid, wire, wire strainer, support straps, glue and fittings as shown. Bench not included.

With Mist Controller, wet leaf, solenoid, glue and fittings as shown. Bench not included.

Length (m)	1m wide bench	Price £
1	MA1H1	400.00
2	MA1H2	430.00
3	MA1H3	460.00
4	MA1H4	501.00
5	MA1H5	531.00
6	MA1H6	561.00
7	MA1H7	601.00
8	MA1H8	632.00
9	MA1H9	662.00
10	MA1H10	692.00
Extra 1m run	MNH1.0M	36.00

Length (m)	1.5m wide bench	Price £
1.25	MA2H1	400.00
2.50	MA2H2	430.00
3.75	MA2H3	471.00
5.0	MA2H4	501.00
6.25	MA2H5	531.00
7.5	MA2H6	562.00
8.75	MA2H7	602.00
10	MA2H8	632.00
11.25	MA2H9	663.00
12.5	MA2H10	703.00
Extra 1.25m run	MNH1.25M	36.00

Length (m)	1m wide bench	Price £
1	MA1V1	380.00
2	MA1V2	401.00
3	MA1V3	431.00
4	MA1V4	452.00
5	MA1V5	472.00
6	MA1V6	503.00
7	MA1V7	523.00
8	MA1V8	554.00
9	MA1V9	574.00
10	MA1V10	603.00
Extra 1m run	MNV1.0M	28.00

Length (m)	1.5m wide bench	Price £
1.25	MA2V1	380.00
2.50	MA2V2	401.00
3.75	MA2V3	431.00
5.0	MA2V4	452.00
6.25	MA2V5	482.00
7.5	MA2V6	503.00
8.75	MA2V7	523.00
10	MA2V8	554.00
11.25	MA2V9	574.00
12.5	MA2V10	605.00
Extra 1.25m run	MNV1.25M	28.00

DATA SHEET ONLINE

Polyphosphate Descaler

Limescale is a major problem in irrigation – especially in Mist Propagation units and drippers.

- Simple Cartridge based system
- Mounting bracket and spanner included
- Easy Installation

How it Works

In 'hard water' areas Calcium precipitates out of the water supply causing scale build up on pipe walls, dripper outlets and plant leaves. Traditionally Nitric acid dosing is used to sequester the calcium, requiring large quantities of acid.

The polyphosphate descaler uses small quantities of long chain polyphosphates (derived from phosphoric acid) to act as a 'crystal modifier'. By modifying the crystalline structure these compounds will not precipitate into scale and actually stay in solution. Over time already deposited mineral scale deposits will also dissolve.



	Connection	Code~	Price £
Polyphosphate Descaler	1" F	EFBP	130.00
Spare Polyphosphate cartridge		EFBP-C	54.00
5 micron sediment pre-filter	1" F	EFBS	120.00
Spare sediment cartridge		EFBS-C	45.00

Wet Leaf

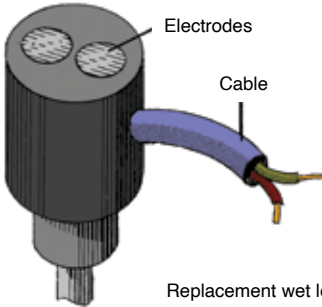

Replacement wet leaf.
We recommend replacement every few years.

	Code	Price £
2.5m lead	MWL-2.5M	39.00

Will fit Macpenny wet leaf controllers.

Access Solenoid Valves 24V AC



- Rating: 3.8W
- Pressure range: 0.5-10 bar
- 3/4" BSPM inlet/outlet
- Fibreglass polyamide body
- 2 mounting pillars for self-tapping screws
- Inlet strainer

	Code	Price £
	ESVA3	22.00

Install vertically, horizontally but not up-side-down!

Amber Mist Nozzle



Output at 3.5 bar	Recommended bed width			1/2" BSPM		
	Size	Risers ▲	Tunnel ▼	Code	Price £	
25 l/h	0.6mm	1.0m	1.0m	MA2-24	18.00	
46 l/h	0.8mm	1.5m	1.5m	MA2-32	18.00	
Anti drip insert					MAA	11.00

- Stainless steel jet and anvil
- Anti-drip option for upside-down use
- Glass filled nylon frame

This nozzle has a 1/2" BSPM thread. Ideal pressure 3.5 bar. For a low pressure option, use Mini-mist nozzles p10.



~ see p52

Sprinklers

The sprinkler nozzle is the most important part of your system, so we only use top quality nozzles. Unlike old fashioned nozzles, our modern sprinklers have been designed to provide optimum distribution, while keeping precipitation rates low to prevent crop and compost damage.

Half Circle This nozzle uses the Eindor taper system, see p38. Ideal working pressure 2-3 bar.



Output at 2 bar	Colour	Bed width Risers ▲	Sprinkler Spacing	Pack of 10		Pack of 100	
				Code	Price £	Code	Price £
40 l/h	Blue	1.0m	1.0m	KEASH40-T	6.50	KEASH40-H	58.00
70 l/h	Black	1.3m	1.5m	KEASH70-T	6.50	KEASH70-H	58.00
90 l/h	Green	2.0m	2.0m	KEASH90-T	6.50	KEASH90-H	58.00

- Fine spray in half circle
- Low cost
- Ideal for narrow display benches

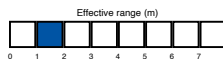

Mini-mist This nozzle uses the Eindor taper system, see p38. Ideal pressure 2-4 bar.



Output at 2 bar	Colour	Bed width Risers ▲	Sprinkler Spacing	Pack of 10		Pack of 100	
				Code	Price £	Code	Price £
20 l/h	Green	1.0m	1.0m	KEAF020-T	6.50	KEAF020-H	50.00

- 50-150 micron droplets
- Low cost propagation
- Ideal for cooling

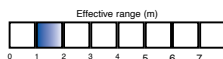

Vibro-spin This nozzle uses the Eindor taper system, see p38. Ideal working pressure 2 bar.



Output at 2 bar	Colour	Bed width Risers ▲	Sprinkler Spacing	Pack of 10		Pack of 100	
				Code	Price £	Code	Price £
60 l/h	Grey	1.5m	1.5m	KE060-T	6.00	KE060-H	43.00
70 l/h	Black	2.0m	1.8m	KE070-T	6.00	KE070-H	43.00
105 l/h	Blue	2.5m	2.0m	KE105-T	6.00	KE105-H	43.00

- Self cleaning nozzle
- Rotating anvil evens distribution
- Ideal for plug plants

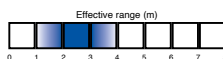

Mini-spin This nozzle uses the Eindor taper system, see p38. Ideal working pressure 2 bar.



Output at 2 bar	Colour	Bed width Risers ▲	Sprinkler Spacing	Pack of 10		Pack of 100	
				Code	Price £	Code	Price £
40 l/h	Silver	2.2m	2.0m	KES040-T	9.80	KES040-H	86.00
70 l/h	Black	3.0m	2.5m	KES070-T	9.80	KES070-H	86.00
105 l/h	Blue	3.2m	2.5m	KES105-T	9.80	KES105-H	86.00
120 l/h	Red	4.0m	3.0m	KES120-T	9.80	KES120-H	86.00

- Twin water jets
- Low water consumption
- Ideal for windy sites

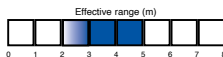

Mini-spin Tunnel This nozzle uses the Eindor taper system, see p38. Ideal working pressure 2 bar.



Output at 2 bar	Colour	Bed width Risers ▼	Sprinkler Spacing	Pack of 10		Pack of 100	
				Code	Price £	Code	Price £
70 l/h	Black	5.0m	2.5m	KESU070-T	8.60	KESU070-H	76.00
105 l/h	Blue	5.2m	2.5m	KESU105-T	8.60	KESU105-H	76.00
120 l/h	Red	5.5m	2.5m	KESU120-T	8.60	KESU120-H	76.00
160 l/h	Brown	5.7m	2.5m	KESU160-T	8.60	KESU160-H	76.00

- Designed for upside-down use
- Low water consumption
- Ideal for tunnel watering

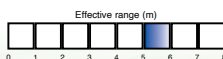

DATA SHEET ONLINE

DATA SHEET ONLINE

Tall Bedding Spike Set



Designed for taller borders, the 1m galvanised steel rods can be pushed into the ground to give a nozzle height of 70 – 80cm.

- 1m small bore connecting pipe.
- Top fitting accepts Eindor taper fittings
- Barbed plunger for polythene pipe – requires 3mm punch – see p4.

Qty	Code	Price £
10	KRGV-T	75.00
100	KRGV-H	521.00

Bedding Spike



- Use for borders and frames
- Top fitting accepts Eindor taper nozzles
- Barbed plunger for polythene pipe – use punch (p4)



Qty	Height	Code	Price £
10	0.35m	KRBS-T	19.00
100		KRBS-H	132.00

Stake Riser



- Low cost
- Secures to customers own stake – includes straps
- Top fitting accepts Eindor taper nozzles
- Base has barbed plunger for polythene pipe



Qty	Height	Code	Price £
10	1.2m	KRSR-T	40.00
100		KRSR-H	322.00

Spiked Riser



- Use on grass or soil
- Connect hose with 'Geka' hosesails or plastic Quick Connector
- 3/4" BSPM sprinkler fitting
- Includes adaptor for Eindor taper nozzles



	Height	Code	Price £
'Geka' fittings	0.7m	KRST0.5	28.00
QC inlet	0.7m	KRST0.5Q	17.00

Small Shrub Head

This nozzle has a 1/2" BSPF thread. Ideal pressure 2.8 bar

DATA SHEET ONLINE



Output	Material	Maximum radius	Code	Price £
150 - 1200 l/h	Plastic	4.6 - 11.3m	KHPGJ-SH	20.00

Adjustable Arc

Output			
Nozzle	Bars	Radius	m ² /hr
0.75	2.8	4.9	0.17
1.0	2.8	5.8	0.23
1.5	2.8	6.7	0.34
2.0	2.8	7.6	0.45
2.5	2.8	8.5	0.57
3.0	2.8	9.4	0.68
4.0	2.8	10.4	0.91
5.0	2.8	11.3	1.14

Large Shrub Head

This nozzle has a 3/4" BSPF thread. Ideal pressure 2.0 - 4.0 bar



Output	Material	Maximum radius	Code	Price £
110 - 3270 l/h	Plastic	8.5 - 15.8m	KHPGS	21.00

Adjustable Arc

Output @ 3.5 bar		
Nozzle	Radius	m ² /hr
1.5	9.8m	0.38
2.0	10.4m	0.47
2.5	10.7m	0.58
3.0	11.9m	0.74
4.0	12.2m	0.97
5.0	12.8m	1.24
6.0	13.1m	1.47
8.0	13.7m	1.95





Naan 501

DATA SHEET ONLINE



This nozzle has a 1/2" BSPF thread

- Low precipitation rate
- Turbo hammer operation
- Low cost

	Blue
Spacing (m)	4 x 4
	4 x 6
	6 x 6
	6 x 8*
	8 x 8*
Output @ 2 bar	180 l/h
Pressure Range	1.5 - 3 bar
Diameter	14.5 - 15m
Code	KN5-200
Price £	13.00

Naan 5022U

DATA SHEET ONLINE



- Low precipitation rate
- Wide spacings
- Unique nozzle design for higher uniformity

This nozzle has a 1/2" BSPM thread

Great coverage at a low flow

Spacing (m)	9 x 10
	10 x 10
	9 x 12
	10 x 12*
	12 x 12*
Output @ 2.5 bar	350 l/h
Pressure Range	2 - 4 bar
Diameter	19m
Code	KN52-360
Price £	17.00

Naan Adjustable

DATA SHEET ONLINE



These nozzles have a 1/2" BSPM thread



- Plastic or metal body
- Part or full circle
- Adjustable height and range
- Diffuser pin

Spacing (m)	Plastic	Plastic	Metal
	8 x 10	8 x 10	8 x 10
	10 x 10	10 x 10	10 x 10
		10 x 12*	10 x 12*
		12 x 12*	12 x 12*
Output @ 2.5 bar	450 l/h	850 l/h	850 l/h
Pressure Range	1.5 - 4 bar	1.5 - 4 bar	1.5 - 4 bar
Diameter	21 - 24m	21 - 26m	23 - 28m
Code	KNPC-500	KNPC-940	KNPCM-940
Price £	19.00	14.00	23.00

*at higher pressure

Adaptors



A

B

C

Adaptor	Riser	Sprinkler	Code	Price £
A	3/4" BSPM	1/2" BSPF	FPTI2-3	0.80
B	1/2" BSPM	1/2" BSPM	FPTS2	1.00
C	3/4" BSPM	1/2" BSPM	FPTS3-2	1.10





Large Spiked Riser

- Use on grass or soil
- Includes 'Geka' fittings
- Connect hose with 'Geka' hose tails
- ½" BSPM thread
- Available with or without nozzle



Nozzle	Height	Code	Price £
—	1.06M	KRLS	61.00
Naan 501	1.06M	KRLS-N	71.00

Heavy Duty

Cross Base Riser

- Use on hard standings
- Includes 'Geka' fittings
- Connect hose with 'Geka' hose tails
 - ½" BSPM thread
 - Available with or without nozzle



Nozzle	Height	Code	Price £
—	1.06M	KRLX	76.00
Naan 501	1.06M	KRLX-N	88.00

Heavy Duty

Sled Riser

TRIPOD
RISER
ONLINE

- Use on concrete or soil
- Includes 'Geka' fittings
- Connect hose with 'Geka' hose tails
- ¾" BSPM thread
- Available with or without nozzle



Nozzle	Height	Code	Price £
—	0.36m	KRSA	59.00
Naan 501	0.36m	KRSA-N	72.00

Spike with Sprinkler



- Metal spike for turf watering with ½" BSPF top thread
- Snap connector fitting
- Can be 'daisy chained'
- Available with or without sprinkler nozzle (6.4m radius)



Nozzle	Code	Price £
—	KR004	11.00
MP2000	KRST2K	25.00

Hand Watering

Professional Watering Lance

The best watering lance we have come across, this beautifully balanced US manufactured lance has a solid brass on/off valve with a smooth valve action. Now available as a 75cm lance for better reach. Low Flow rose (170AL) is ideal for domestic gardens.



60cm Lance

Rose	Fitting	Code	Price £
400AL	Quick Conn	ELANCE60DQ	89.00
400AL	'Geka' type	ELANCE60DG	88.00
170AL	Quick Conn	ELANCE60DQS	80.00

75cm Lance

Rose	Fitting	Code	Price £
400AL	Quick Conn	ELANCE75DQ	105.00
400AL	'Geka' type	ELANCE75DG	104.00
170AL	Quick Conn	ELANCE75DQS	94.00

Professional Watering Roses



1. 400 Water Breaker
42 l/min @ 2.7 bar.



2. 170 Water Breaker 26 l/min
@ 2.7 bar. Low Flow rose – ideal
for domestic gardens.



3. Seedling nozzle with micro
holes. Needs filter.
34 l/min @ 2.7 bar.

No	Item	Code	Price £
1	400AL	EHPRA	37.00
2	170AL	EHPRB	24.00
3	1000PL	EHPRC	28.00
	Filter	EHPRD	37.00

Metal Spray Gun

8 function aluminium bodied spray gun with brass quick connector.

- Mist • Full • Cone
- Shower • Angle
- Flat • Soaker • Jet

Protect from frost.



	Code	Price £
Metal spray gun	EHGUN	25.00

Geka "Softrain" Lance

Comes complete with metal valve and large alloy rose with 'Geka' fitting.



Length	Code	Price £
40cm	ELANCE40	39.00
60cm	ELANCE60	43.00
90cm	ELANCE90	43.00

To use with hose Quick Connectors, replace the 'Geka' with an FQCBM3 (page 17)

Geka Watering Roses



No.	Rose	Code	Price £
1	Large Alloy	EHRAR	13.00
2	Small Alloy	EHRAS	20.00
3	Spare Metal Tap	EVL3MF	11.00



Tricoflex Hose



20 Year Guarantee



- 1 Outer layer is both U.V. and abrasion resistant
- 2 Yellow colour for easy visibility
- 3 Knitted reinforcement combines pressure resistance with excellent handling characteristics
- 4 Multi-layer construction ensures superb kink resistance
- 5 Smooth inner layer ensures optimum water flow and restricts algae growth.

Size ID	25m Coil		50m Coil		100m Coil	
	Code	Price £	Code	Price £	Code	Price £
½"/12mm	PHT2-25M	42.00	PHT2-50M	83.00	PHT2-100M	180.00
¾"/19mm	PHT3-25M	70.00	PHT3-50M	140.00	PHT3-100M	300.00
1"/25mm	PHT4-25M	120.00	PHT4-50M	230.00	PHT4-100M	450.00

Brass Hose Couplers



Hose couplers allow the permanent connection of hosepipe onto threaded fittings. Requires a hose clip. Female fitting includes leather seal.

Hose-Thread	Code	Price £
¾" - 1" Male	FHB3-4	9.40
1" - 1" Male	FHB4-4	11.00
¾" - ¾" Female	FHB3-3F	5.60
¾" - 1" Female	FHB3-4F	12.00
1" - 1" Female	FHB4-4F	7.10

'Geka' Type Hose Fittings

Uncouples with a ¼ turn. Allows different size hoses to be joined.



Male BSPM



Qty	Code	Price £
½"	FGBM2	3.30
¾"	FGBM3	3.50
1"	FGBM4	3.80

Female BSPM



7/8" to fit outlet of ¾" Bib tap ETB3

Qty	Code	Price £
½"	FGBF2	3.80
¾"	FGBF3	3.40
7/8"	FGBF78	5.30
1"	FGBF4	3.50

Hosetail



The easy fit 'Geka' on p22 saves scraping your knuckles on a hose clip!

Qty	Code	Price £
½"	FGBH2	3.70
¾"	FGBH3	3.90
1"	FGBH4	4.80

Spare Seals

Pack of 10 in re-sealable bag



Code	Price £
FGRS-1	5.90

Blanking Cap



Code	Price £
FGBSE	3.60

'Y' Piece



Code	Price £
FGBY	18.00

Hose Clips



Zinc plated. Genuine Jubilee hose clips - beware of cheap imitations!

Range	Hose Size	Code	Price £
13-20mm	½"	FHC2	1.40
17-25mm	¾"	FHC3	1.50
25-35mm	1"	FHC4	1.60
35-50mm	1¼"-1½"	FHC6	1.80
50-70mm	2"	FHC8	2.10

~ see p52

Hose Trolleys



1 Bolted steel frame with solid tyres.
Light duty – ideal for gardens.



2 Welded steel frame with solid tyres.
Medium duty – not suitable for sports use.



3 Welded steel frame with pneumatic tyres.
Heavy duty – ideal for sports and nursery use.



4 Welded steel frame



5 Swivel

No.	Capacity (m)			Connector	Code ~	Price £
	½"	¾"	1"			
1	100			QC	EHRC2	220.00
2	50			¾" hose	EHRC3	260.00
3a		80	45	'Geka'	EHRC4S	500.00
3b		120	70	'Geka'	EHRC4	570.00
3c		150	100	'Geka'	EHRC4L	680.00
4a	50	40		½"	EHRWS2	220.00
4b	100	70		½"	EHRWL2	280.00
5	50	40		½"	EHRWSV	250.00

4 Welded steel frame

5 Welded steel frame with swivel arm

Hose Hanger

Keep your hose tidy with this heavy duty professional hose hanger

Has 3 fixing holes to secure to the wall.

Takes 100m ½" hose or 50m ¾" hose.



Code	Price £
EHHH	56.00

Top quality Italian fittings

Manifolds

2 Way Manifold



- Built in taps
- Teflon seals
- Protect from frost

	Code	Price £
¾" M threads	ET2M3	34.00
Quick connector	ET2MQ	29.00

3 Way Manifold



- Built in taps, ¾" M threaded outlet.
- Teflon seals
- Protect from frost

Screws onto standard outside taps to give 2 or 3 outlets

Code	Price £
ET3M3	50.00

Brass Quick Connectors Compatible with plastic systems

Tap Connector



¾" F for ½" tap.

Code	Price £
FQCBT3	3.80

Male Adaptor



½" or ¾" male thread.

	Code	Price £
½"	FQCBM2	3.90
¾"	FQCBM3	3.90

¾" Male Adaptor



Connector with ¾" male thread. Snaps on to Tap connector etc.

Code	Price £
FQCBS3	12.00

Hose Connector



For ½" and ¾" hose. Snaps on to Tap connector etc.

	Code	Price £
½"	FQCBH2	9.90
¾"	FQCBH3	13.00

Shut off Connector



For ½" hose. Shuts off when disconnected.

	Code	Price £
½"	FQCBH2S	13.00

Hose-Hose Connector



For ½" and ¾" hose. Joins 2 hoses.

	Code	Price £
½"	FQCBJ2	8.20
¾"	FQCBJ3	11.00

Revolving Elbow



¾" female thread.

Code	Price £
FQCE3	14.00

Easy-fit 'Geka' Hosetail



For ½" and ¾" hose. Easier to fit than a traditional 'Geka' hosetail.

	Code	Price £
½"	FQCBG2	9.60
¾"	FQCBG3	10.00

Hose Coupler



Joins 2 hose connectors.

Code	Price £
FQCBK3	4.60

Replacement Seals



Replaces male sealing ring. Pack of 10.

Code	Price £
FQCRS-T	4.60

Here is a "snap on" / "snap off" system. We use tough brass quick release connectors, much tougher than domestic plastic fittings - and are fully compatible. It is easy to connect together and there are no "horrid" hose clips! 

Landscape

Irrigation is vital if plants are to establish quickly, especially when conditions are warm and dry. Irrigation also ensures newly planted specimens have a far better chance of survival, and that plants and lawns in high traffic areas are able to recover. As well as the components and kits available in this section, Access produce a companion catalogue – the 'Landscape Pocket Guide' which includes sample irrigation designs for small to medium sized landscape projects. For larger projects, Access also have an experienced design department.



Border Watering Kit



Keep precious plants watered even in hot, dry spells with this border sprinkler kit.

The system consists of a black pipe running the length of the border, with spiked risers fitted as required.

Each riser has a choice of nozzle to suit the border width. Branching tees and elbows are included. Connect to an outdoor tap or a garden hose. Simple to install. Needs punch, see p4.



- What you get:**
- 10 sprinkler risers
 - 50m pipe (20mm)
 - Tap connector
 - Fittings
 - 10 large sprinklers
 - 10 medium sprinklers
 - 10 half-circle nozzles

Covers up to 75m² (25m x 3m wide)

Code	Price £
SBW	125.00

Nozzle	KES040	KES070	KEASH40
Bed width	2.0m	3.0m	1.0m
Sprinkler Spacing	2.0m	2.5m	1.8m

Small Border Watering Kit



For smaller gardens this kit will water an entire border with water efficient sprinklers.

The system consists of a black pipe running the length of the border with spiked risers fitted every 2m.

Branching tees and elbows are included. Connect to an outdoor tap or garden hose. Simple to install. Needs punch, see p4.

- What you get:**
- 10 sprinkler risers
 - 25m pipe (16mm)
 - Tap connector
 - Fittings
 - Medium Sprinklers (KES040)

Covers up to 40m² (20m x 2m wide)

Code	Price £
SBW25	77.00



Components

Installing large numbers of systems?
Then buy in Bulk!

	10 Pack	Price £	100 Pack	Price £
Stake Sets	KRBS-T	19.00	KRBS-H	132.00
Stake only	KESSL-T	7.30	KESSL-H	66.00
Head only	KEH-T	2.00	KEH-H	18.00
1m lead	L42-1.0-T	9.90	L42-1.0-H	93.00
Pipe Plunger	KEP-T	2.00	KEP-H	15.00

For Pipe see page 40; for barbed fittings see page 41.

Alternative nozzles are available on page 10.



Border Spray Watering Kit



Covers up to 30m²
(12.5m x 2.5m wide)

- Gentle spray
- Simply installs at the front of the border
- Can be automated

Designed to water a border up to 3m deep from the front, the kit is ideal for more established borders. The system uses sprinklers on small metal spikes up to 3m apart. 16mm black polythene pipe runs along the front edge of the border.

The sprinkler nozzles provide a very fine spray, so delicate plants are not damaged.

Connects to a garden hose or a tap. Minimum pressure: 2.1 bar. Requires DB valve (p27) to comply with domestic water regulations.



Code	Price £
SBMP4	196.00

What you get:

- 25m pipe (16mm)
- Tap connector
- Fittings
- 4 sprinklers on metal spikes

Popup Border Spray Kit



- Gentle spray on 300mm riser
- No pipework visible
- Can be automated

Designed to water a border up to 3m deep from the front, the system uses pop-up sprinklers that **rise 300mm out of the ground** when watering. A single trench along the front of the bed contains all of the pipe and the sprinklers, eliminating unsightly pipework on the bed.

The sprinkler nozzles provide a very fine spray, so delicate plants are not damaged.

Fits to a garden hose, a tap or an underground valve box (p23). Minimum pressure: 2.1 bar. Requires DB valve (p27) to comply with domestic water regulations.



Code	Price £
SBMP5	292.00

Covers up to 37m²
(15m x 2.5m wide)

What you get:

- 25m pipe (20mm)
- Tap connector
- Fittings
- 5 sprinklers on 12" pop-up bodies



Border Drip Kit



Covers up to 60m²



What you get:

Small	Large	
25m	100m	Drip Line
25	100	Anchorage pegs
1	1	Barbed fittings pack
1	1	Inlet filter
1	1	Hose connector
1	1	Tap connector

	Covers	Code	Price £
Small	15m ²	SPBK25	55.00
Large	60m ²	SPBK	139.00

Drip irrigation is the most efficient and unobtrusive way of watering beds, with water dripping directly into the soil. The drip line is brown to make it as unobtrusive as possible, although it can be covered with a mulch to make it invisible.

The Permadrip drip line is made from a thick walled polythene pipe with commercial grade pressure compensated drippers spaced every 0.5m for even coverage. Simple to install.

The kit can either be connected directly to an outdoor tap, or can be connected to a hose with a standard quick connector. Requires DB valve (p27) to comply with domestic water regulations.

Hedge Drip Kit



- Speed up establishment for faster screening
- Reduces plant losses
- Can be automated

Using thick walled commercial grade dripline with drippers every 0.3m, this package is ideal for watering hedge lines to speed up establishment and reduce plant losses.

A single line of dripline is needed down each hedge run.

The kit can either be connected directly to an outdoor tap, or can be connected to a hose with a standard quick connector. Requires DB valve (p27) to comply with domestic water regulations.

What you get:

Small	Large	
25m	100m	Drip Line
25	100	Anchorage pegs
1	1	Inlet filter
1	1	Hose connector
1	1	Tap connector

Dripline Starter Pack

Allows dripline to be easily connected to an outside tap or to a hose using a snap connector. For beds supplied using underground pipe, the threaded fitting can be connected to a compression fitting. The kit also includes a stop end connector and a straight connector in case plain pipe (see p40) is being used to connect from the tap to the border

Code	Price £
FBSP16	7.30



Anchorage Pegs

Fit every 0.5 - 1.0m to hold the drip line down. Fits 16/20mm.

Sturdy barbed pegs for more grip



Qty	Code	Price £
25	ESS16-Q	9.40
100	ESS16-H	33.00



Permadrip Pro



**1.2mm
PIPE
WALL**



Measure bed

Easy Installation

At last – a really simple dripper system

- The most efficient way to water
- Anti-siphon design resists clogging
- Brown to blend in
- Pressure compensated – ideal for long runs
- Thick walled for durability



Lay and peg



Connect up



Connect to tap

For Barbed Fittings see p41 



Your Questions Answered

How far apart do I space Permadrip?
Space runs 0.6m apart. Use the 0.3m spacing Permadrip for providing extra water around trees. Bending radius, 18cm.

How much do I need?
Work out the area of the beds (in m²) and double. This is how many metres of 0.5m spaced Permadrip you need.

How much can I use?
It depends on your water supply. Measure your supply in l/hr (see p37). Divide this by 3.2 for 0.5m spacing (5.3 for 0.3m spacing) this is how many metres you can run at a time.

What about Water Regulations?
For house gardens you can run Permadrip on the surface if you add a DB valve. See p27.

How long should I run it for?
Approximately 30 mins per day in dry weather or one hour three times a week.

Operating range: 0.8-3.5 bar
Nozzle Output: 1.6 l/h
Maximum length (0.5m): 165m
Recommended Filter: 0.13mm

Length	Spacing	Code	Price £
25m	0.15m	TNT0.15-Q	34.00
100m	0.15m	TNT0.15-H	134.00
25m	0.30m	TNT0.3-Q	31.00
100m	0.30m	TNT0.3-H	109.00
25m	0.50m	TNT0.5-Q	30.00
100m	0.50m	TNT0.5-H	103.00



0.5m spacing for borders



0.3m spacing for hedge runs

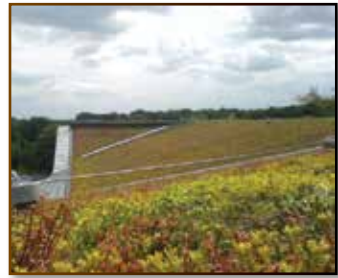

0.15m spacing for green roofs and tree pits



Small Temporary Lawn Kit



Covers up to 90m²
(14.3m x 6.4m)

- Temporary system for smaller lawns
- Designed with professional sprinklers
- Easy to put out and take away

Using metal spiked risers for the lawn topped with professional quality sprinkler nozzles from Hunter and commercial grade 1/2" hose, this kit quickly and easily connects together to water the lawn, either during establishment or during hot, dry spells.

If the system is run for 4 hours at night it will gently put the equivalent of 1 weeks worth of rain down on the lawn – a timer will automate this.

Includes 3 risers with nozzles, 25m professional grade hose, quick connectors and tap fittings.

Code	Price £
SLMP3	210.00

What you get:

- 3 sprinklers
- 25m 1/2" hose
- Fittings
- Tap connector



Temporary Lawn Watering Kit



5 RISER KIT AVAILABLE ONLINE



Laid a new lawn?

Use this system to help it establish. Add an automatic controller for fully automatic operation.

Includes 3 risers, each with a sprinkler that covers 10m diameter, 25m of hose and all fittings required.

Code	Price £
STLW	348.00

Covers up to 250m²
(25m x 10m wide)

What you get:

- 3 risers and sprinklers
- 25m 3/4" hose
- Fittings
- Tap connector

Lawn Watering Kit



OTHER SIZE KITS ONLINE

Code	Price £
SLW3	113.00



Covers up to 250m²
(25m x 10m wide)

What you get:

- 25m pipe (20mm)
- Tap connector
- Fittings
- 3 pop-up sprinklers with interchangeable nozzles

Nothing looks better than a well watered lawn, and this pop-up sprinkler kit makes installation very easy.

3 pop-ups are included, each one can have its radius adjusted between 4.9m and 9.1m, and its arc adjusted between 40° and 360°. 25m of pipe and all fittings are included, as is a tap connector.

Note: Water Regulations require pop-up sprinklers in commercial premises to be protected by a break tank. For home gardens, check with your water supplier.

Underground Valve Boxes



For a neater installation, hide all of the control valves underground.

For warning label see page 44.

	Battery	Price £	Mains	Price £
2 zone	EPAV02	206.00	EPAB02	170.00
4 zone	EPAV04	311.00	EPAB04	235.00

3 Simple Steps

1 Select Valve Chambers

Choose one or more valve boxes to bring water to the various areas of the garden. If you are having a battery powered controller, choose a battery valve box.

2 Choose Controller

Choose mains or battery powered controller to suit your needs.

3 Select Cable

If the controller is remote from the valve box, measure how much cable is needed to run from the controller location to the valve boxes.

Controller not included - see pages 28-29

Tap Link Kit for Valve Boxes

The kit consists of a 2-way brass manifold that screws onto the outdoor tap – allowing the tap to still be used for filling a watering can or connecting a hose. On the other outlet of the manifold 25m of underground pipe runs from the tap position to the valve box.

Tap and backplate are not included.



Pipe Size	Code	Price £
20mm x 25m	STK20	76.00

Border Link Kit

The Border Link Kit allows up to 4 separate beds to linked back to either a valve box or an outside tap using underground pipe. The kit can supply water to either border drip kits or border sprinkler kits. By linking the beds together underground the irrigation system becomes much less obtrusive and is easier to automate.

The kit consists of 25m of underground supply pipe, 4 take off points (one for each bed) and connections for either a standard garden tap or to an underground valve box.

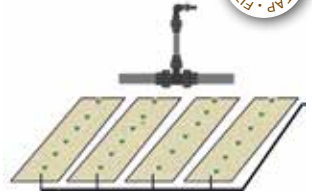

Code	Price £
SLK4	61.00

Tap Manifold



A simple way of fitting manifolds to the tap, kits will suit battery operated controllers or mains powered controllers. Includes valves and link pipe but not tap or controller.

Inlet: 3/4" F

Outlet: 3/4" M or 1" F

Controller not included - see pages 28-29

Controller Type	Zones	Code	Price £
Battery	2 zone	EPAG02	155.00
	4 zone	EPAG04	260.00
Mains	2 zone	EPAT02	117.00
	4 zone	EPAT04	175.00



Rotator Sprinklers



- Matched Precipitation
- NEW side strip
- Water efficient



1/2" BSPF thread

Water efficient sprinklers with 'matched precipitation' which allows different nozzles and arcs to be used on the same zone while maintaining uniformity. The new 'Pro' body has a heavy duty spring, a check valve and 5 year warranty. The sprinkler is regulated to 2.8 bar pressure.

	Code	Price £
4" Pop up only	KHPPR	2.80
Box of 10 sprinklers	KHPPRBX	23.00
4" Pro body (2.8 bar regulated)	KHPPH	14.00
Box of 10 sprinklers	KHPPHBX	114.00
12" Pop up only	KHPPR-12	21.00

Hunter MP Rotator Nozzles



The original MP Rotator nozzle, manufactured by one of the leading sprinkler manufacturers in the world, this range offers unrivalled options in terms of arc and radius adjustment. All stated radii can be reduced by up to 25% using the nozzle key.

Radius	Radius @ 2.8 bar	Arc	Colour	Code	Price £	
1.8-3.5m	2.4m	100 l/h (180°)	90° - 210° 360°	Orange / Grey	KHMP8A	11.00
		180 l/h (360°)		Lime Green	KHMP8C	11.00
3.7-4.5m	4.1m	40 l/h (90°)	45° - 105° 90° - 210° 210° - 270° 360°	Turquoise	KHMP1D	11.00
		80 l/h (180°)		Maroon	KHMP1A	11.00
		130 l/h (270°)		Lt. Blue	KHMP1B	11.00
		170 l/h (360°)		Olive	KHMP1C	11.00
5.2-6.4m	5.8m	170 l/h (180°)	90° - 210° 210° - 270° 360°	Black	KHMP2A	11.00
		250 l/h (270°)		Green	KHMP2B	11.00
		330 l/h (360°)		Red	KHMP2C	11.00
7.6 - 9.1m	9.1m	410 l/h (180°)	90° - 210° 210° - 270° 360°	Blue	KHMP3A	11.00
		620 l/h (270°)		Yellow	KHMP3B	11.00
		830 l/h (360°)		Grey	KHMP3C	11.00
10.4-10.7m	10.7m	650 l/h (180°)	90° - 210°	Light Brown	KHMP4A	11.00
Threaded female adaptor to 1/2" BSPM thread					KHMPAD	3.90

Operating pressure: 1.7 bar-3.8 bar. Largest radii are achieved at max pressure



Strip Sprinklers			
Coverage	Nozzle @	Code	Price £
Between 1.2m x 3.7m and 1.8m x 5.2m	L/H Corner	KHMP1H	11.00
	R/H Corner	KHMP1R	11.00
Between 1.2m x 7.3m and 1.8m x 10.4m	Centre of one side	KHMP5S	11.00

Nozzle Adjustment Key



Code	Price £
KHKMP	2.30

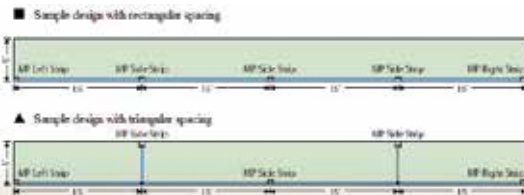



Pop-up Sprinklers

Hunter pop-ups are renowned for their quality and reliability.

	Check Valve	Flo-stop	Gear Drive	0	2	4	6	8	10	12	14	16	18	20	22	m radius
MP				[Bar chart showing coverage from 0 to 10m]												
PGJ			✓	[Bar chart showing coverage from 0 to 6m]												
I20	✓	✓	✓	[Bar chart showing coverage from 0 to 14m]												
I25	✓	✓	✓	[Bar chart showing coverage from 0 to 22m]												

PGJ

DATA SHEET ONLINE



This economically priced 'baby' version of the PGP sprinkler is ideal for mid-sized grass areas.

- Easy nozzle changing
- Waters more economically than sprays
- Slim design
- Adjustable arc 40° – 360°

½" BSPF thread

	Code	Price £
4" body	KHPGJ	16.00
Box of 10	KHPGJBX	120.00
Check Valve	KHPGJC	1.60

Large sports sprinklers available (page 48)

Nozzle	Bars	Radius	m ² /hr
0.75	2.0	4.6m	0.14
1.0	2.0	5.5m	0.19
1.5	2.0	6.4m	0.29
2.0	2.0	7.3m	0.37
2.5	2.0	8.2m	0.49
3.0	2.0	9.1m	0.56
4.0	2.0	10.1m	0.83
5.0	2.0	11.0m	1.06

PGP Ultra

Each sprinkler comes with a set of standard and low angle nozzles

DATA SHEET ONLINE



The world's best selling rotor just got better, with a range of new features.

- Vandal-proof drive mechanism
- Thicker, safer top cover
- Slotted screw for easy adjustment
- Adjustable arc 50° – 360°

¾" BSPF thread

3 Year Guarantee

	Code	Price £
4" sprinkler body	KHPGP	17.00
Box of 10 sprinklers	KHPGPBX	153.00
Short radius nozzles	KHP-NSR	1.10
Check Valve (3m)	KHPGPC	1.60

Low Angle Nozzles @ 2.5 bar			
Nozzle	Radius	m ² /hr	
2.0LA	7.9m	0.40	
2.5LA	8.8m	0.53	
3.5LA	9.1m	0.68	
4.5LA	9.1m	0.84	

Short Radius Nozzles @ 2.5 bar			
Nozzle	Radius	m ² /hr	
.50SR	5.2m	0.09	
1.0SR	5.2m	0.17	
2.0SR	5.2m	0.36	
.75SR	7.0m	0.15	
1.5SR	7.0m	0.28	
3.0SR	7.0m	0.60	

Standard Nozzles @ 2.5 bar			
Nozzle	Radius	m ² /hr	
1.5	9.4m	0.32	
2.0	10.1m	0.39	
2.5	10.7m	0.48	
3.0	11.0m	0.61	
4.0	11.9m	0.81	
5.0	11.9m	1.02	
6.0	12.2m	1.22	
8.0	12.5m	1.63	

I20 Ultra

Each sprinkler comes with a set of standard and low angle nozzles

DATA SHEET ONLINE



The I20 is the professional version of the Hunter PGP.

In addition to the features of the PGP, the I20 has:

- FloStop control for individual nozzle shut-off
- Check valve to prevent puddling
- Heavy duty construction with stainless steel riser

¾" BSPF thread

	Code	Price £
4" sprinkler body	KHP20	40.00
Box of 10 sprinklers	KHP20BX	370.00
Short radius nozzles	KHP-NSR	1.10

Low Angle Nozzles @ 3.5 bar			
Nozzle	Radius	m ² /hr	
2.0LA	8.5m	0.48	
2.5LA	10.1m	0.64	
3.5LA	10.7m	0.80	
4.5LA	10.7m	1.00	

5 Year Guarantee

Short Radius Nozzles @ 3.5 bar			
Nozzle	Radius	m ² /hr	
.50SR	5.5m	0.12	
1.0SR	5.5m	0.23	
2.0SR	5.5m	0.45	
.75SR	7.6m	0.17	
1.5SR	7.6m	0.34	
3.0SR	7.6m	0.67	

Standard Nozzles @ 3.5 bar			
Nozzle	Radius	m ² /hr	
1.5	9.8m	0.38	
2.0	10.4m	0.47	
2.5	10.7m	0.58	
3.0	11.9m	0.74	
4.0	12.2m	0.97	
5.0	12.8m	1.24	
6.0	13.1m	1.47	
8.0	13.7m	1.95	

I25 Ultra

DATA SHEET ONLINE



Designed for large scale turf watering.

- Throws up to 21m
- Check valve prevents puddling
- ProTech top for playing fields

1" BSPF thread

5 Year Guarantee	
Code	Price £
KHP31	80.00

Nozzle	Bars	Radius	m ² /hr
7	3.4	14.3m	1.59
10	4.1	15.8m	2.52
15	4.8	17.4m	3.45
20	4.8	19.2m	4.36
25	4.8	20.7m	5.79

Accessories



	Code	Price £
Nozzle Key	KHKEY	1.00
Nozzle insert collar	KHCOL	1.80



	Code	Price £
12" swing joint ½" top	KHSJ12-2	3.60
12" swing joint ¾" top	KHSJ12-3	3.60

¾" base thread fits to tees or saddles (see page 42)



Hanging Basket System

Easy Installation



Fit to tap



Clip to wall



Cut to length



Insert tee dripper



Fit lead and stake



Turn on



The ideal way to water baskets and tubs

- Easy to install
- Unobtrusive pipework
- Ultra-low flow dripper for reduced run off
- Top quality nozzles for reliability
- Can be automatic

Hanging baskets and planters enhance any property, but are a nightmare to water. Now, with this easy to install system, everything can be watered with the turn of a tap.

The Access dripper kit uses an ultra-low flow dripper for reduced run off from the basket. The pressure compensating nozzle ensures that the output is the same whether the drippers are at eaves or ground level. It also allows 6mm piping to be used. This is only pencil thick and is black for long life. Pipe clips with masonry nails are supplied to fix to brick or timber.

An adaptor enables the system to be connected to the outlet of your tap. For completely automatic watering see p28.



Dripper



Stake

What you get:		
Small	Large	
10	25	Drippers
10	25	Stakes
25	100	Pipe clips
1	3	Branching tees
20m	40m	Pipe
1	1	Tap connector

Saves hours of time!

Waters up to 25 baskets

Pipe Length	Water fed in at:		Spacing Type
	One End	The Centre	
25m	83	145	▲
50m	57	121	▲▲
75m	46	106	▲▲▲
100m	39	96	▲▲▲▲
200m	27	71	▲▲▲▲▲
50m	40	—	●
100m	28	—	●●

* P13 pipe calculated with 3.5 bar input pressure

- ▲ = drippers equally spaced down length of pipe
- = drippers predominantly at the far end of the pipe



	Code	Price £
Small kit	DW10BK	39.00
Large kit	DW25BK	79.00

Contractor Packs

Everything you need to get you going, ideal for installing systems around pubs, restaurants and patio areas. On the large kit all small components are housed in one reusable and re-sealable container. Contractor packs also come with P14 supply pipe that has a 4.0mm ID for increased flow, allowing 40% more drippers to be run than the P13 pipe.



Kit	Code	Price £
Large	DWCP	250.00
Small	DWCPH	150.00

		What you get:	
Small	Large		
75	100	Drippers and stakes	
100m	100m	6mm x 4mm ID P14 pipe	
20m	60m	5.5mm x 3.5mm ID P13 pipe	
200	200	Pipe clips	
10	30	Branching tees	
10	20	Straight connectors	
50	100	Stop ends	
3	10	Tap connectors	
—	1	Re-usable components box	

Components

Installing large numbers of basket systems? Then buy in bulk!			
		Code	Price £
Tee Drippers (1.2 l/h)	10	D1PCT-T	7.50
	25	D1PCT-Q	17.00
	100	D1PCT-H	63.00
Stakes	25	DAS-Q	4.50
	100	DAS-H	13.00
Supply Pipe Only (4mm ID)	100m	P14-100M	43.00
Supply or Drripper Pipe (3.5mm ID)	20m	P13-20M	25.00
Branching Tees	10	FBT6-T	3.80
	100	FBT6-H	23.00
Straight Connectors	10	FBK6-T	2.50
	100	FBK6-H	11.00
Stop Ends	10	PA12=1-T	1.50
	100	PA12=1-H	7.00
Hammer Clips	25	FPCN6-Q	2.50
	100	FPCN6-H	7.20
Tap fittings with filters	1	DWTF	3.30
	10	DWTF-T	19.00

DB Valve and Kit



Water regulations require a DB valve to be fitted 300mm above the highest dripper. The fixing kit gives the parts required to fit the valve into the small bore pipe at high level.

Inlet: ¼" F Outlet: ¾" M

	Code	Price £
DB Valve	EVDB3	178.00
Fixing Kit	EVDB3KT	4.00

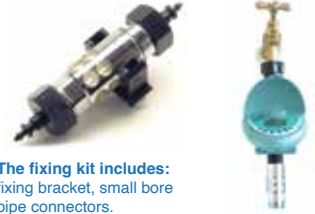

The fixing kit includes: fixing bracket, small bore pipe connectors.

Hanging Basket Feeder

Feeding baskets has always been a problem, especially as the small compost volumes of a basket and the regular watering required conspire to rob the plants of the nutrients they need.

The feeder is connected to the irrigation pipework. Inside is a slow release fertiliser which feeds every time you water. Two cartridges should last a season and the first cartridge should be replaced after 2 months.

Flow range:	1 – 200 l/h
Max pressure:	4.0 bar (58 psi)
Fittings supplied:	Connector for 3.5-4.0 mm ID pipe Brass quick connectors

	Code	Price £
Hanging Basket Feeder	AFBP	68.00
Replacement Cartridge	AFBP-C	21.00



Brass quick connector



Small bore connector



Control Systems

Battery Controllers

Battery operated controllers are becoming increasingly sophisticated and reliable, and allow automatic control anywhere – making them ideal for remote locations. We carefully select controllers, ensuring they will endure the damp – vital in Britain! Batteries will last a whole season. **Always protect controllers from frost.**

Galconette – Single Station



A simple, reliable tap timer with large display and plenty of features. Manual over-ride with auto off function.

	Code	Price £
Galconette	EPAGT	89.00
Battery (1 needed)	C280-9V	2.30

Galcon – 4 Station



Controller can either be mounted on a valve or wall mounted (bracket included). Manual over-ride.

	Code	Price £
4 station controller only	EPAGDC4	140.00
1" valve (fit up to 4)	EPAGV	45.00
Battery (1 needed)	C280-9V	2.30
Rain sensor	ERS	56.00

• Button operation	• Rain off button
• Screws directly on to an outdoor tap (3/4" F x 3/4" M)	
✓ 4 starts per day	✗ Cycling option
✓ 1min - 12hr watering time	✓ 1 year battery life (average)
✗ Seasonal adjust	✗ Rain sensor option

• Rain off button	• For outdoor use
• Each station can be programmed independently	
✓ 4 starts per day	✗ Cycling option
✓ 1min - 12hr watering time	✓ 1 year battery life (average)
✓ Seasonal adjust	✓ Rain sensor option

Hunter Pro Tap Timers

This rugged timer is controlled via a Bluetooth app on your Smartphone. Push-button manual start to allow up to 1 hour of watering. Two irrigations modes with two start times each.

One or two outlet options. 2 year warranty. Pressure: 0.5-8 bar



	Code	Price £
Single outlet	EPART01	94.00
Twin outlet	EPART02	170.00

• App programming with manual button	• Rain delay up to 7 days via app
• Screws directly on to an outdoor tap (3/4" F x 3/4" M)	
✓ 2 starts per day (4 or 2 zone)	✓ Cycling option
✓ 1min – 6hr watering time	✓ 2 x 1.5v AA batteries included
✗ Seasonal adjust	✗ Rain sensor option



Hunter X2 Controller



Easy-to-configure control panel for up to 14 zones, including 3 programs and 4 start times each. Plug in the revolutionary WAND module to allow remote management and advanced water-saving features using the Hydrawise software. Hydrawise maximises water savings by automatically adjusting irrigation schedules based on the local weather. It also compatible with Amazon Alexa™ and Control4® home automation. 2 year warranty.

• Easy to use dial	• Lockable outdoor controller
• Rain off setting on dial	• Optional WAND with Hydrawise software
✓ 12 starts per day	✗ Cycling option
✓ 1min – 12hr watering time	✓ Non volatile memory
✓ Seasonal adjust	✓ Rain sensor option



WAND module

	Code	Price £
4 Zone X2 controller	EPARX04	166.00
8 Zone X2 controller	EPARX08	245.00
14 Zone X2 controller	EPARX14	369.00
Rain sensor	ERS	56.00
WAND upgrade	EPARXWF	194.00
Roam Kit	EPARIRC	262.00

Hunter-pro-HC controller



This commercial grade controller comes with 6, 12 or 24 zones and has a 7cm colour touchscreen with built-in Wi-Fi, allowing remote programming via a PC or via an app. Hydrawise maximises water savings by automatically adjusting irrigation schedules based on the local weather. Easily install a Flow Meter to accurately monitor flow, prevent wasted water and avoid damaged landscape. 2 year warranty.

• 7cm full colour touch screen	• Lockable outdoor controller with key
• 2 sensor ports	• Wifi with Hydrawise software
✓ 36 starts per day	✗ Cycling option
✓ 1min – 24hr watering time	✓ Non volatile memory
✓ Seasonal adjust	✓ Rain sensor option

	Code~	Price £
6 zone controller	EPAY06	530.00
12 zone controller	EPAY12	630.00
24 zone controller	EPAY24	1100.00
Flow meter	EFAYFM	236.00
Roam Kit	EPARIRC	262.00

Hunter Node Controller



This waterproof timer is ideal for valve box installations, removing the need to lift dirty covers to alter the settings. Controlled via a Bluetooth app on your Smartphone. Three irrigation modes with 8 start times each. 2 year warranty.



	Code	Price £
Single zone with 1" valve	EPARN01	143.00
4 zone controller only	EPARN04	194.00
1" solenoid valve	EPAGV	45.00
Soil moisture sensor	EPARNS	53.00
9v battery (accepts 1 or 2)	C280-9V	2.30

• App programming with manual button	• Rain delay up to 99 days via app
• Need text	
✓ 24 starts per day	✓ Cycle and soak
✓ 1sec– 12hr watering time	✓ 1 year battery life (average)
✓ Smart weather adjust	✓ Moisture sensor option

Heron Multi-wire



**3 Year
Warranty**



The all-new Heron HM multi wire controller features a much larger display for easier programming and easy naming of individual zones.

One of the most dependable and sophisticated controllers on the market with optional rain sensors, flow monitoring and cellular remote control.

By adding a SIM, the unit can be controlled and programmed from your computer. Adding a flow meter then allows remote monitoring.

A sophisticated rain sensor measures rainfall in 1mm increments for precise control.

Stations	Code	Price £
16 zone expandable controller	EPAH16	680.00
Rain sensor with bracket	EPAHRB	124.00

Plastic case; digital settings; LCD display; input 240v; output 24v AC @ 1.3A; pump start; electronic fuse; timing range; 1 sec to 60 min & 1 min to 60 hrs.

• Remote start	• Programme freeze
• Multiple programmes	• Delay between valves
• 3 year warranty	• Fertigation option
• 16 station units are expandable to 144 zone	
✓ 64 starts per day	✓ Cycling option
✓ 1sec – 10hrs watering time	✓ 5 year battery backup
✓ Seasonal adjust	✓ Rain sensor option

Solenoids and Low Voltage Cable

Bermad Valves 24V AC



24v AC coil can be used on 12v DC outputs.

- Rating: 1.7W
- Pressure range: 0.7 – 10 bar
- Flow control stem
- Manual over-ride

	Code	Price £
1" BSPF	ESVB4	39.00
1½" BSPF	ESVB6	91.00
2" BSPF	ESVB8	110.00
Spare Coil	ESVBC24V	24.00

Hunter Valves 24V AC



- Versatile and robust
- Flow control
- Flow rate: 0.05 – 9 m³/hr
- Pressure range: 1.5 – 10 bar

	Code	Price £
1" BSPF	ESVP4	28.00

Hunter PGV Battery 9V DC



- Designed for battery systems
- Flow control stem
- Flow rate: 0.05 – 9 m³/hr
- Pressure range: 1.5 – 10 bar

	Code	Price £
1" BSPF	EPAGV	45.00

Accu-Sync for Hunter



- Adjustable pressure regulation (1.5 – 7 bar)
- Works with Hunter PGV valves
- Max pressure rating: 10 bar

	Code	Price £
Accu-sync	ESVHAS	69.00

Low Voltage Cable

Heavy duty 0.8mm cable for wiring solenoids. 1 core needs to be used for the 'common return', so a 4 core cable will wire 3 solenoids etc.

	10m	Price £	100m	Price £
4 Core Cable	ELCS04-T	27.00	ELCS04-H	130.00
6 Core Cable	ELCS06-T	32.00	ELCS06-H	180.00
12 Core Cable	ELCS12-T	72.00	ELCS12-H	390.00

Connectors



Easy to use - no wire stripping needed.

	Qty	Code	Price £
Grease filled connectors for joining cable to Solenoid valves	10	ELCG-T	14.00
	50	ELCG-L	61.00

Cable & Crimps



2.5mm Hunter approved 2 core decoder cable.
Grease connector allows easy connection of cables with grease pot to prevent corrosion.

	Code ~	Price £
2 core decoder cable 250m	ELCS2D-25H	810.00
2 core decoder cable 500m	ELCS2D-5H	1400.00
Grease connector	ELCGD	4.50

Floating Level Switch



3 wire design allows circuit to open or close on contact.
Suitable for high or low water applications.

Lead	Code	Price £
3m	EWTFLO3	63.00
10m	EWTFLO10	87.00

Floating level switches stop pump damage if you run out of water.

Pressure Switch



6 bar pressure switch

Code	Price £
EPUPS06	CALL

Pressure Vessels



Capacity	Bar	BSPM	Code ~	Price £
20 L	10	1"	EPV020LV	CALL
60 L	10	1"	EPV060LV	CALL
100 L	10	1"	EPV100LV	CALL

5 Way Kit



5 Way Kit consists of:

- 1" 5 way tee
- 1" non-return valve
- 1" brass nipple
- 10 bar pressure gauge

5 way kit

Code	Price £
EPVSK06	CALL

Braided Pipes



1m connecting pipe
1" BSPF x 1" BSPM

Code	Price £
EPBH1M	58.00

~ see p52

Pumps

Horizontal Pumps



DATA SHEET ONLINE

High quality pumps

- Stainless steel body and shaft
- IP55 continuous rated motor
- Built-in thermal protection
- Ceramic/Carbon/EDPM seal
- Full after sales service

Self Priming



BG Series



SHM Series

3 phase also available

Model	Max h	FLOW (m³/hr) @ xxm head								SINGLE PHASE				Price £
		20m	30m	40m	50m	60m	70m	80m	90m	In/Out BSPF	kW	F.L.C. Amps	Code	
BGM7/A		2.6	1.3							1 1/4" / 1"	0.75	5.00	EP1BG07	690.00
BGM11/A		4.2	2.2	0.5						1 1/4" / 1"	1.10	6.47	EP1BG11	870.00
5HM04P	49m	6.3	4.7	2.4						1 1/4" / 1"	0.75	4.79	EP15HM04~	1130.00
5HM06P	73m	6.5	5.5	4.2	2.5					1 1/4" / 1"	1.10	6.84	EP15HM06~	1860.00
5HM08S	58m	8.5	7.9	5.8	3.5					1 1/4" / 1"	0.95	5.97	EP15HM08~	2090.00
5HM09S	66m			8.5	6.9	5.5	3.4			1 1/4" / 1"	1.10	6.87	EP15HM09~	2110.00
5HM11S	82m		9.0	8.2	7.1	5.7	4.4	2.3		1 1/4" / 1"	1.50	8.42	EP15HM11~	2720.00
5HM13S	97m			8.5	8.2	6.2	5.7	5.2	3.4	1 1/4" / 1"	2.20	10.00	EP15HM13~	2750.00

Installer approved! Our installers love these quality pumps for their reliability and ease of draindown and maintenance.

Lowara Vertical Pumps

These vertical pumps are ideal for larger flows. For more 'mission critical' applications we also sell the Lowara range of pumps which boast a network of service engineers for fast breakdown assistance.

MORE PUMPS ONLINE

DATA SHEET ONLINE

Model	Max h	FLOW (m³/hr) @ xxm head							SINGLE PHASE					Price £	
		30m	40m	50m	60m	65m	70m	75m	In/Out BSPF	Phase	kW	F.L.C. Amps	Code ~		
10SV04		11.9	8.0							1 1/2" / 1 1/2"	Single	1.5	8.58	EP110SV04	3420.00
10SV05		14.5	11.6	8.0						1 1/2" / 1 1/2"	Single	2.2	11.60	EP110SV05	3570.00
10SV06		15.6	13.3	11.0	8.0	6.0				1 1/2" / 1 1/2"	Single	2.2	11.60	EP110SV06	3630.00
10SV06		15.6	13.3	11.0	8.0	6.0				1 1/2" / 1 1/2"	Three	2.2	4.64	EP310SV06	3220.00
10SV07			14.0	12.3	10.5	9.7	8.0	6.1		1 1/2" / 1 1/2"	Three	3.0	6.19	EP310SV07	3240.00



Genyo Auto-start Unit



Converts pumps so that they start automatically when a pressure drop is detected, such as when a tap is opened or an irrigation valve operates.

- IP65 rated body
- 1" BSPM inlet and outlet
- Operates pumps up to 16 amps
- Max 10 bar pressure
- Pressure Gauge included

Pressure Losses	
Loss (m)	Flow m³/hr
2	3.4
5	5.2
10	7.5

	Code	Price £
Genyo	EPUPSTF	340.00
Union	FPTU4-4F	27.00



Union fitting

Allows the Genyo unit to always face forward and to be removed from the pump without unwiring the entire unit.

~ see p52

River and Lake Pump Package

Professional pump system

Designed for easy pumping from wells and rivers the package includes a DAB900X auto-start submersible pump, suspension kit, disc filter and 25m of pipe. Will handle moderately sediment loads. For dirtier water upgrade a floating inlet and to a semi-automatic filter (p36).

For fully automated irrigation using river water, pair up with a valve box (p23) and controller.



What you get

- DAB900X auto-start pump
- Isolator switch
- Stainless steel suspension chain
- 1" Disc filter and shutoff valve
- 25m of 25mm MDPE pipe

Code	Price £
EPPKLR	930.00

Suction Hose



EWTRPI Floating inlet

		Code	Price £
1"	Suction Hose 5m	PHS4-5M	46.00
	Suction Hose 30m	PHS4-25M	180.00
	1" BSP Male Coupling - brass	FHB4-4	11.00
	1" BSP Female Coupling - brass	FHB4-4F	7.10
	Super Clamp	FHSC4	2.70
2"	Suction Hose 5m	PHS8-5M	72.00
	Suction Hose 30m	PHS8-30M	340.00
	2" BSP Male Coupling - brass	FHB8-8	39.00
	2" BSP Female Coupling - brass	FHB8-8F	32.00
	Super Clamp	FHSC8	3.60
Floating inlet for 1" suction hose		EWTRPI	62.00
1m suction hose pre-assembled 1" BSPF		PHS4C-1M	37.00

Auto-start Submersible



DAB900X

Auto-start copes with 'water-out' situations

Designed to cope with 'water out' situations, the pump will automatically stop if the water supply runs out, then periodically try to restart until the water supply returns. Built-in non-return valve. DAB650 and 900X require a buffer vessel to protect the pump. DAB55X is a variable speed pump so will cope with high and low water flows. Minimum flow: 120 l/h



EPBV4 Buffer vessel



EWTRPI-1M Floating inlet with 1m hose



Model	FLOW (m ³ /hr) @ xxm head				In BSPF	Out BSPF	F.L.C. Amps	Code	Price £
	20m	30m	40m	50m					
DAB 650	3.2	—	—	—	—	1"	2.9	EP1V06	490.00
DAB9 00X	4.1	3.1	1.65	—	1"	1"	4.2	EP1V09X	560.00
DAB 55X	5.75	5.1	4.5	3.75	1"	1¼"	5.0	EP1V55X~	1520.00
Floating inlet with 1m suction hose and 1" BSPM thread								EWTRPI-1M	91.00
Buffer vessel with 1" BSPM thread								EPBV4	120.00
Suspension kit for polythene tanks – includes 1.5m stainless steel chain and securing bracket								EPSK	44.00
Submersible pump kit for wells with 3m stainless steel chain & bracket								EPWK	88.00

+ see p52

Designed to boost the pressure of the water supply

- Complies with the Water Regulations
- Simple to Install

These units are designed for systems where pressure is a problem or compliance with the Water Regulations is required. The units are pre-assembled and simply need to be connected to a power and mains water supply.

Pre-assembled Pump Unit



Designed for easy pump installation the pump is supplied mounted on a plate and pre-wired with a Genyo auto-start unit and to an isolator switch.

The auto-start unit brings the pump on as soon as a drop in pressure is detected.

Includes 1m of suction hose with 1" BSPF fittings to connect to an irrigation tank outlet.

Suitable for Lowara horizontal pumps – **pump NOT included.**

Code ++	Price £
EPPKHA	1000.00

Compact Pressure Booster Units



Designed for lower flows where compliance with the Water Regulations is required. The flow from the unit must be less than or equal to the flow into the tank.

200L: Ø 650mm x 1100mm high

Inlet: 3/4" BSPM Outlet: 1" F

Pump	FLOW (m ³ /hr)@xxm head				Code ++	Price £
	20m	25m	30m	40m		
DAB 650	3.2	2.2	—	—	EPTS0200L	1560.00
DAB 900X	4.1	3.6	3.1	1.6	EPTS0200	1770.00

500L Pressure Booster Unit



Tank holds a buffer of water allowing the pump to operate at higher flows

610mm x 1060mm x 1330mm high

Inlet: 3/4" BSPM

Outlet: 1" BSPF

Head	Flow (m ³ /hr)
20m	4.1
30m	3.1
40m	1.65

Code ++	Price £
EPTS0500	2100.00

1250L Pressure Booster Unit



Tank holds a buffer of water allowing the pump to operate at higher flows. Two pump options.

1200mm dia x 1200mm high

Inlet: 3/4" BSPM

Outlet: 1" BSPF

Pump	FLOW (m ³ /hr) @ xxm head				Code ++	Price £
	20m	30m	40m	50m		
DAB1200X	4.1	3.1	1.65	—	EPTS1250	2240.00
DAB55X	5.75	5.1	4.5	3.75	EPTS1250H	3340.00

++ see p52

Pump Relay



This reliable pump relay box provides a simple interface between pump and 24v AC signal from the controller. No low water over-ride. Lockable enclosure.

FLC Amps	Code	Price £
12	ESB1PH	199.00

Pump Isolator



Pump isolator is required for all pump installations. Single phase.

FLC Amps	Code	Price £
25	ESBI	51.00

Pre-assembled Tanks with Air Gap

Includes air gap to comply with water regulations, inlet ball valve, overflow, tank outlet with gate valve.

Inlet: 3/4" BSPM

Outlet: 1" BSPF

Capacity	Ø x H mm	Code ++	Price £
200 L	650 Ø x 780	EPTS0200-TANK	461.00
500 L	615 x 900 x 1200	EPTS0500-TANK	692.00
1250 L	1200 Ø x 1200	EPTS1250-TANK	727.00
2000 L	1200 Ø x 1960	EPTS2000-TANK	864.00



Polythene Tanks

- UV stabilised polythene
- Access hatch
- Threaded outlets



Water regulations require irrigation tanks to have a Type 'AB' overflow.

2 Year Guarantee

Capacity	Outlet	Ø x H mm	Code ~	Price £	
1,250 L	278 Gal	1.5" M	1200 x 1200	EWTX1250	320.00
2,000 L	440 Gal	1.5" M	1200 x 1960	EWTX2000	420.00
2,500 L	550 Gal	1.5" M	1400 x 1800	EWTX2500	440.00
5,000 L	1,100 Gal	2" M	1900 x 2185	EWTX5000	870.00
10,000 L	2,100 Gal	2" M	2400 x 2500	EWTX10K	1350.00
12,500 L	2,750 Gal	2" M	2600 x 2600	EWTX12K	1620.00

These tanks are made from black MDPE, maintenance free and have an 18" or 24" screw hatch.

Needs large lorry access and unloading facilities. Craned or remote deliveries will be charged extra.



~ and ++ see p52

Filters



Screen Filter

- Fine filter suitable for drip systems
- Twin pressure gauge ports on 2" models
- Washable filter
- Amiad Tagline range



Max Flow	Thread Size	Filter Size	Maximum Pressure	Code	Price £
3 m ³ /h	¾" M	0.13mm	8 bar	EFP3-0.1	16.00
7 m ³ /h	1" M	0.13mm	8 bar	EFP4-0.1	23.00
15 m ³ /h	1½" M	0.13mm	8 bar	EFP6-0.1	98.00
25 m ³ /h	2" M	0.13mm	8 bar	EFP8-0.1	180.00

Disc Filter



- Ideal for dirtier water applications
- Disc provides greater filtration area
- Fine filter suitable for drip systems

Max Flow	Thread Size	Filter Size	Maximum Pressure	Code	Price £
3 m ³ /h	1" M	0.13mm	6 bar	EFPD4-Y	43.00
8 m ³ /h	1½" M	0.13mm	10 bar	EFPD6-Y	255.00

Filter in Washer



Fits ¾" F fittings.

Code	Price £
P67	1.20

Semi-automatic Filter

DATA SHEET ONLINE



Semi-automatic filter with built-in cleaning nozzles for fast and effective filter cleaning. Integrated clogging meter automatically indicates when cleaning is required.

Plastic ribbed filter body with stainless steel 'weave-wire' with a large filtration capacity.

Max Flow	Thread Size	Filter Size	Maximum Pressure	Code ~	Price £
40 m ³ /h	2"	0.13mm	10 bar	EPPA8-0.1	550.00

Pressure Regulators

Can fit in any orientation.



	Flow Rate	Pressure Range	Spring Colour	Code	Price £
¾" F x ¾" M Adjustable Delrin	0.01 - 5m ³ /h	0.8 - 2.5 bar	Yellow	EPR3LFM-B*	55.00
	0.2 - 5m ³ /h	2.0 - 4.0 bar	Red	EPR3FM-C	28.00
	0.4 - 8m ³ /h	0.5 - 1.2 bar	White	EPR4F-A	60.00
1" F x 1" F Adjustable Acetal	0.4 - 8m ³ /h	1.0 - 2.0 bar	Red	EPR4F-B	60.00
	0.4 - 8m ³ /h	1.5 - 3.5 bar	Black	EPR4F-C	60.00
	0.4 - 8m ³ /h	3.0 - 5.5 bar	Brown	EPR4F-D	60.00

*¾" F x ¾" F

Tank Fittings

	Polythene Tanks	Code	Price £
1	Chamber for Stopcock	KHB10	16.00
2	Stopcock	FLSC20	48.00
3	Drain Point	EWDT20	24.00
4	Female Elbow	FLE20-3F	2.70
5	¾" ball valve with float	ETVB3	132.00
6	Overflow Weir Mesh	EWTFWEIR	28.00
7	Floating Level Switch-3m	EWTFLO3	63.00
8	Tank Connector	FUTTC4	18.00
9	1" Gate Valve	EVG4	23.00
10	20mm blue water pipe	PE20-25M	33.00
	1" Tank Overflow	ETOF4	28.00

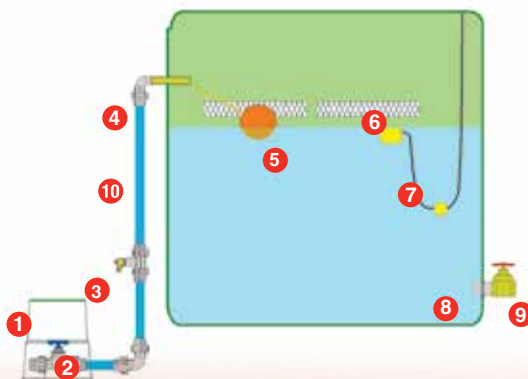

Fittings

Introduction

We only choose good quality fittings to put in our catalogue – we are often surprised at the poor quality parts that are around.

To make life less complicated we tend to stock all the popular sizes – if you have a large requirement for something unusual please give us a call.

Contents

Threaded Fittings	39
Pipe & Pipe Clips	40
Barbed Fittings	41
Compression Fittings	42
Meters & Tools	44
Threaded Valves & Taps	45
uPVC Pipe & Fittings	46
Eindor Taper Fittings	48
Filters & Valve Boxes	49

Terminology

O.D.	= pipe outside diameter
I.D.	= pipe inside diameter
LDPE	= low density polyethylene
MDPE	= medium density polyethylene
HDPE	= high density polyethylene
c/p	= Co-polymerised (for longer life)
uPVC	= grey plastic, rigid pipe
PVC	= soft, flexible pipe
Potable	= drinking water

Imperial/Metric Conversion

Inch	0.3937	1	2.54	centimetres
Foot	3.28074	1	0.3048	metres
Yard	1.093613	1	0.91440	metres
Acres	2.47105	1	0.40469	hectares
Pint	1.75976	1	0.56826	litres
Gallon	0.21997	1	4.54609	litres
US Gal	0.2642	1	3.7854	litres
Pound	2.204622	1	0.453592	kilograms
Psi	14.5038	1	0.069895	bar
e.g. 1 inch = 2.54cm 1cm = 0.3937 inches				



Stuck without a ruler? Use a coin!

5p = 18mm diameter 10p = 24mm diameter
2p = 26mm diameter £2 = 28mm diameter

Identification Tables

Thread Sizes

The O.D. of the thread and its size are different. For example a ½" thread has an O.D. of approx ¾".

BSP Thread	¼"	⅜"	½"	¾"	1"	1¼"	1½"	2"
Male thread OD mm	13	17	21	26.5	33.6	42	48	60
Female thread ID mm	11.5	15	18.6	24	30	38.5	45	57

Imperial Pipe

Like thread sizes, the O.D. and the pipe size are different. Wall thicknesses are denoted by its class. Black polythene pipe was generally class B, C or D. Rigid grey uPVC pipe was class C, D, E or T. We can supply adaptor fittings - please ask our sales department.

Pipe Size	⅜"	½"	¾"	1"	1¼"	1½"	2"
OD mm	17.2	21.4	26.5	33.6	42.2	48.3	60.3

Metric Pipe

The pipe is measured by the O.D. Below 12mm diameter there are no standard sizes - so beware when matching small bore pipe.

Pipe OD mm	12	16	20	25	32	40	50	63
Blue MDPE water pipe (12 bar)			✓	✓	✓		✓	✓
Black MDPE water pipe (10/12 bar)			✓	✓	✓	✓	✓	✓
Black LD/MDPE pipe (4/6 bar)	✓	✓	✓	✓	✓	✓	✓	✓
Grey uPVC pipe (5-16 bar)		✓	✓	✓	✓	✓	✓	✓

Copper Pipe

Available in O.D. sizes 15, 22, 28, 35, 42 mm.

If you can't easily work out the OD of a pipe, wrap a strip of paper round and mark where it overlaps. This will then give circumference of pipe. Divide by pi (3.1428) to give pipe diameter.

Want to know your water flow?

Take a container of a known volume (e.g. 10l) and time how many seconds it takes to fill with the tap 3/4 open (e.g. 20 seconds). Divide the volume by the time then multiply by 3600. e.g. $\frac{10}{20} \text{ (bucket size)} \times 3600 = 1,800 \text{ l/h}$

Eindor Taper Fittings

We have been using these fittings for many years – the push fit design has been tested to 6 bar!

Pre-packed in resealable, labelled bags. Easy to open, easy to identify.
We try to be helpful!



12mm Connector

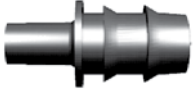

For 12mm OD poly. Bottom end fits 6mm F fittings eg KEP.

Qty	Code	Price £
25	KECL-Q	4.10
100	KECL-H	13.00

12mm End Connector

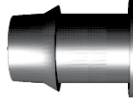

6mm F outlet. Adapts Vibro-spin and Mini-spin to 12mm OD poly pipe.

Qty	Code	Price £
10	KEEC-T	2.70
100	KEEC-H	18.00

Plunger



Small barb fits 3.5mm - 4.0mm ID pipe. Large barb fits into 3mm hole punched into side wall of pipe - see p4 for punches.

	Qty 10	Price £	Qty 100	Price £
Small	KEPS-T	3.60	KEPS-H	25.00
Large	KEP-T	2.00	KEP-H	13.00

1/2" M Adaptor



6mm F outlet. Adapts Vibro-spin, Mini-spin, Mini-fogger nozzle to 1/2" F thread. Will fit KESL stake.

Qty	Code	Price £
10	KEM-T	5.90
100	KEM-H	50.00

Barbed Collar



Small barb fits 3.5mm - 4.0mm ID pipe. Large barb fits 6.8mm x 4.00mm downtubing.

	Qty 25	Price £	Qty 100	Price £
Small	KECS-Q	9.00	KECS-H	31.00
Large	KEC-Q	3.70	KEC-H	11.00

Tee



6mm F.

Qty	Code	Price £
10	KET-T	2.80
100	KET-H	17.00

Threaded Caps



Allows nozzles and fittings to be converted to BSPF threads. Cap outlets fit Mini-spin and Vibro-spin nozzles.

Thread	Qty 10	Price £	Qty 100	Price £
1/2" - F	KECP2-T	6.00	KECP2-H	49.00
3/4" - F	KECP3-T	6.50	KECP3-H	55.00

Double Nipple



Joins fittings of 6mm F.

Qty	Code	Price £
25	KEN-Q	4.30
100	KEN-H	14.00

Blanks



KEB

Allows male or female fittings to be blanked off.

To blank	Qty 25	Price £	Qty 100	Price £
Female	KEB-Q	3.00	KEB-H	8.10
Male	KECAP-Q	4.30	KECAP-H	13.00

Mini-Tap



6mm M x F inlet/outlet Fit with KECS/KEPS to fit small bore pipe.

Qty	Code	Price £
10	KEV-T	9.50
100	KEV-H	92.00

Threaded Adaptors



Allows nozzles and fittings to be threaded into overhead irrigation pipes.

Thread	Qty 10	Price £	Qty 100	Price £
M11	KEPM-T	1.80	KEPM-H	11.00
1/2" W	KEPT-T	2.10	KEPT-H	12.00
3/8" W	KEPW-T	2.50	KEPW-H	18.00

Repair Plugs



Allows punched holes in pipes to be repaired.

Qty	Code	Price £
100	FBG5-BAG	6.80

Threaded Fittings

These are polypropylene and rated at 6 bar

Installer Approved!
Some plastic fittings are very poor -
but we think these are excellent. 

Socket



F	Code	Price £
½"	FPTS2	1.00
¾"	FPTS3	0.90
1"	FPTS4	1.20
1½"	FPTS6	4.30
2"	FPTS8	5.50

Tee



F	Code	Price £
½"	FPTT2	2.20
¾"	FPTT3	2.40
1"	FPTT4	3.00
1½"	FPTT6	6.90
2"	FPTT8	10.20

Tee - Male



MMM	Code	Price £
¾"	FPTT3M	1.30

Tee - Female Branch



FMF	Code	Price £
¾"	FPTT3MF	2.70

Elbow



F	Code	Price £
½"	FPTE2	1.60
¾"	FPTE3	2.40
1"	FPTE4	2.70
1½"	FPTE6	6.70
2"	FPTE8	8.80

Nipple



M	Code	Price £
½"	FPTN2	0.30
¾"	FPTN3	0.40
1"	FPTN4	0.90
1"★	FPTN4H	1.70
1½"	FPTN6	1.50
2"★	FPTN8	3.40

Reducing Bush



★ Hansen 16 bar

M-F	Code	Price £
½" - ¼"★	FCTR2-1	4.10
¾" - ½"★	FPTR3-2	2.10
1" - ½"★	FPTR4-2	2.80
1" - ¾"★	FPTR4-3	2.80
1¼" - 1"★	FPTR5-4	4.30
1½" - 1"★	FPTR6-4	4.50
2" - 1½"★	FPTR8-6	5.50

Plug



F-F	Code	Price £
¾"	FPTP3	0.50
1"	FPTP4	0.80

Reducing Socket



F-F	Code	Price £
¾" - ½"	FPTS3-2	1.10
1" - ¾"	FPTS4-3	1.20

Increasing Piece



M-F	Code	Price £
½" - ¾"	FPTI2-3	0.80
¾" - 1"	FPTI3-4	1.50
1½" - 2"	FPTI6-8	5.00

Elbow Male/Female



M-F	Code	Price £
½"	FPTE2MF	1.40
¾"	FPTE3MF	1.90
1"	FPTE4MF	2.20

Elbow - Male



M-M	Code	Price £
¾"	FPTM3M	1.10

Reducing Nipple



M-M	Code	Price £
¾" - ½"	FPTN3-2	0.40
1" - ¾"	FPTN4-3	0.90
1¼" - 1"★	FPTN5-4	3.30
1½" - 1"	FPTN6-4	1.70
1½" - 1¼"★	FPTN6-5	3.90
2" - 1"★	FPTN8-4	3.60
2" - 1½"★	FPTN8-6	3.60

Cap and Washer



'O' Ring
for easy
sealing

F	Code	Price £
½"	FMC2	1.40
¾"	FMC3	1.30
1"	FMC4	1.80
1½"	FMC6	2.30
2"	FMC8	5.00

Polythene Pipe and Clips



Small bore pipe for drip systems see p29

Header & Above Ground Supply Piping – Black							
Size mm	Bar	Wall mm	Material	50m Coil		100m Coil	
				Code	Price £	Code	Price £
16	4	1.2	LDPE c/p	PA16-50M	26.00	PA16-100M	50.00
20	4	1.5	LDPE c/p	PA20-50M	47.00	PA20-100M	75.00
25	4	2.0	LDPE c/p			PA25-100M	94.00
32	6	2.6	LDPE c/p	PB32-50M	88.00	PB32-100M	160.00

Polythene pipe has a number of advantages over uPVC pipe (p46). It is less susceptible to frost damage, does not need solvents to join it and is more resistant to stone damage underground.

Choose pipe with a lower pressure rating for above ground work as it is more flexible. Choose 10 bar rated pipe for underground use where it is more difficult to spot leaks. 

Underground Supply Pipe

- 10 bar black MDPE pipe
- Thick wall for durability
- High pressure rating
- Use compression fittings

Blue water pipe must only be used for potable underground mains water supplies, such as cold water feeds to storage tanks. It must not be used for irrigation water. Black pipe with a green stripe is available for recycled water systems. 

Coil Size	O.D. 20mm Wall 2.5mm	20mm	O.D. 25mm Wall 2.4mm	25mm
	Black	Price £	Black	Price £
25m	PEB20-25M	33.00	PEB25-25M	36.00
50m	PEB20-50M	63.00	PEB25-50M	68.00
100m	PEB20-100M	121.00	PEB25-100M	150.00

Coil Size	O.D. 32mm Wall 3.0mm	32mm	O.D. 50mm Wall 4.6mm	50mm
	Black	Price £	Black ~	Price £
50m	PEB32-50M	111.00	PEB50-50M	265.00
100m	PEB32-100M	213.00	PEB50-100M	470.00

Pipe Clamp and Spacer



Use round head 8/10 screws. (5mm screw hole in sizes up to 32mm. 6mm screw hole and locking clip in 50mm and 63mm)

mm	Clamp		Spacer	
	Code	Price £	Code	Price £
16	FPCM16	0.90	FPCM16S	0.70
20	FPCM20	1.00	FPCM20S	0.70
25	FPCM25	1.20	FPCM25S	0.80
32	FPCM32	1.60	FPCM32S	0.80
50	FPCM50	2.00	FPCM50S	1.30
63	FPCM63	2.90	FPCM63S	1.80

Pipe Clips



Quick, neat way of fixing pipe. Zinc pacified. Boxed in 100s.

mm	Qty 25	Price £	Box	Price £
6	FPCN6-Q	2.60	FPCN6-H	7.30

Small Coil Polypipe



Small coils of black 16mm polythene pipe - ideal for garden use. 1.0mm wall thickness.

Length	Code	Price £
25m	PA16-25M	21.00

Pipe Marking Tape

Complies with WRAS requirements to label all underground irrigation pipes. 250m roll.

Code	Price £
FLWT	81.00

Pin Plug



Use pin plugs where the wall is too hard to hammer the pipe clip nail in. (Use 5mm masonry drill.)

Qty	Code	Price £
25	FPCPP5-Q	4.30
100	FPCPP5-H	7.00

~ see p52

Barbed Pipe Fittings

New design - Easier to fit but greater resistance to pressure. 

Mixed Pack



- 2 x foldover stopend
- 2 x connector
- 2 x tee
- 4 x elbow

mm	Code	Price £
12	FBM12-T	8.20
16	FBM16-T	6.60
20	FBM20-T	7.30

Connector



mm	Qty 10	Price £	Qty 100	Price £
12	FBK12-T	4.80	FBK12-H	35.00
16	FBK16-T	4.80	FBK16-H	37.00
20	FBK20-T	4.80	FBK20-H	37.00

Tee

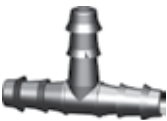

mm	Qty 10	Price £	Qty 100	Price £
12	FBT12-T	6.80	FBT12-H	53.00
16	FBT16-T	5.80	FBT16-H	48.00
20	FBT20-T	6.30	FBT20-H	51.00

Tee Male Branch



mm	½" M Qty 10	¾" M Qty 10	Price £
16	FBT16-2-T	FBT16-3-T	9.00
20	FBT20-2-T	FBT20-3-T	9.00

Elbow



mm	Qty 10	Price £	Qty 100	Price £
12	FBE12-T	5.80	FBE12-H	45.00
16	FBE16-T	5.30	FBE16-H	43.00
20	FBE20-T	6.10	FBE20-H	51.00

Valve - Plastic

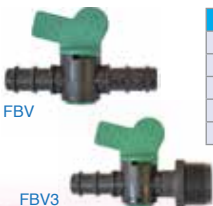

FBV

FBV3

mm	poly x poly	¾" M x poly	Price £
6	FBV6-T*		4.50
12	FBV12		1.70
16	FBV16	FBV3-16	2.30
20	FBV20	FBV3-20	2.20

*FBV6-T is a bag of 10

Sold singly

Stopend



With Cap				
mm	Qty 10	Price £	Qty 100	Price £
16	FBSE16-T	14.00	FBSE16-H	121.00
20	FBSE20-T	14.00	FBSE20-H	121.00

Fold Over				
mm	Qty 10	Price £	Qty 100	Price £
12	TJ12-T	3.30	TJ12-H	30.00
16	TJ16-T	2.20	TJ16-H	17.00
20	TJ20-T	3.10	TJ20-H	25.00

Reducing Connector



mm	Qty 10	Price £	Qty 100	Price £
16-12	FBK16-12-T	4.80	FBK16-12-H	36.00
20-16	FBK20-16-T	5.50	FBK20-16-H	43.00

Tee Reducing Branch



mm	Qty 10	Price £	Qty 100	Price £
16-12	FBT16-12-T	9.20	FBT16-12-H	65.00
20-16	FBT20-16-T	7.80	FBT20-16-H	67.00

Male Connector



mm	½" M Qty 10	¾" M Qty 10	Price £
12	FBK12-2-T	FBK12-3-T	6.30
16	FBK16-2-T	FBK16-3-T	5.50
20	FBK20-2-T	FBK20-3-T	6.30

Elbow x ¾" Male



mm	Qty 10	Price £
16	FBK16-3-T	7.90
20	FBE20-3-T	7.90

Female Connector



Sold singly

mm	¾" F	Price £
16	FBK16-3F	1.00
20	FBK20-3F	1.10

Union fitting allows easy unscrewing. Built in washer.

Never use barbed fittings underground or at full mains pressure - they are cheap and cheerful but not as reliable as compression fittings. For larger sizes use compression fittings, p42. 

Compression Fittings for Metric Polythene Pipe

Coupling



mm	Code	Price £
20	FLK20	3.60
25	FLK25	4.30
25-20	FLK25-20	5.00
32	FLK32	5.50
32-20	FLK32-20	6.30
32-25	FLK32-25	6.60
50	FLK50	14.00
63	FLK63	20.00

Tee Female Branch



mm	¾"F	1"F	1½"F	Price £
20	FLT20-3F			4.10
25	FLT25-3F	FLT25-4F		5.00
32	FLT32-3F	FLT32-4F		7.00
50			FLT50-6F	19.00
63			FLT63-6F	31.00

Female Elbow



mm	¾"F	1"F	1½"F	Price £
20	FLE20-3F			2.70
25	FLE25-3F	FLE25-4F		3.80
32		FLE32-4F		4.50
50			FLE50-6F	17.00

Male Elbow



mm	½"M	¾"M	1"M	Price £
20	FLE20-2M	FLE20-3M		2.60
25			FLE25-4M	3.70

Male Stud



mm	¾"M	1"M	1¼"M	1½"M	2"M	Price £
20	FLM20-3	FLM20-4				2.40
25		FLM25-4				2.80
32		FLM32-4				3.70
50		FLM50-4	FLM50-5	FLM50-6		10.00
63			FLM63-6	FLM63-8		14.00

Female Stud



mm	¾"F	1"F	1½"F	2"F	Price £
20	FLF20-3				2.60
25	FLF25-3	FLF25-4			2.80
32		FLF32-4			4.60
50			FLF50-6		12.00
63				FLF63-8	16.00

Stopcock



Plasson		
mm	Code	Price £
20	FLSC20	48.00
25	FLSC25	51.00
32	FLSC32	71.00
1" BSPF	FLSC4	29.00

Pipe Liner

For blue water pipe.



mm	Code	Price £
20	PEL20	2.40
25	PEL25	2.50
32	PEL32	2.40
50	PEL50	4.90

Tee



Fittings for other sizes available to special order

mm	Code	Price £
20	FLT20	5.30
25	FLT25	6.60
25-20	FLT25-20	6.80
32	FLT32	9.60
32-25	FLT32-25	9.60
50	FLT50	20.00
63	FLT63	33.00

Elbow



mm	Code	Price £
20	FLE20	4.30
25	FLE25	4.90
32	FLE32	6.80
50	FLE50	17.00
63	FLE63	24.00

Cap and Washer



'O' Ring for easy sealing

F	Code	Price £
½"	FMC2	1.40
¾"	FMC3	1.30
1"	FMC4	1.80
1½"	FMC6	2.30
2"	FMC8	5.00

Pipe Saddle



mm	6 bar ¾"F	6 bar 1"F	16 bar 1"F	Price £
25	FS25-3			1.60
32	FS32-3	FS32-4		2.20
50	FS50-3			2.80
50			FS50-4	8.60
63			FS63-4	10.00

Installer Approved!
Not only are these fittings WRC approved - our installers think they are the best thing around - and they have tried them all!

PoziLock Fittings

- Positive sealing
- Increased pressure resistance

Barbed fittings are a low cost way of connecting low pressure polythene pipe. However, their design means that, occasionally, they may drip. This does not matter on a border but, when clipped to a wall, it can look unsightly.

Jubilee clips look a mess and can damage the fitting – making the situation even worse – and high pressure compression fittings are very bulky.

Access have introduced a neat and economical solution – a low pressure compression fitting. With a slim design, these fittings fit into the pipe quickly and neatly and can be easily remade if necessary.



Much easier to fit than barbed fittings - no need for hot water.

Straight



mm	Code	Price £
16	FRK16	2.10
20	FRK20	2.30

Tee



mm	Code	Price £
16	FRT16	3.60
20	FRT20	4.00

Tap Connector



mm	Code	Price £
16	FRF16-3	2.40
20	FRF20-3	2.40

Straight - Male 3/4"



mm	Code	Price £
16	FRM16-3	1.40
20	FRM20-3	1.40

Tee - Male 3/4"



mm	Code	Price £
16	FRT16-3M	2.90
20	FRT20-3M	3.40

On / Off Valve



mm	Code	Price £
16	FRV16	3.90
20	FRV20	4.00

Elbow



mm	Code	Price £
16	FRE16	2.80
20	FRE20	2.90

Tee - Female 3/4"



mm	Code	Price £
16	FRT16-3F	4.00
20	FRT20-3F	4.00

Barb and Grip Ring

Allows any 3/4" threaded fitting to be used for polythene pipe.



mm	Colour	Code	Price £
16	Green	FRG16	1.00
20	Blue	FRG20	1.00

Manifold Parts



10 bar rated

Built in 'O' rings make constructing manifolds really quick and easy.



Tee	Code	Price £
1" x 1" x 1"	KMAT4	5.00
1" x 1" x 1" FFF	KMAT4F	6.90
1½" x 1½" x 1½"	KMAT6	21.00



Elbow	Code	Price £
1" x 1" FF	KMAE4	4.70
1" x 1" MF	KMAE4MF	3.60
1½" x 1½" MF	KMAE6MF	17.00



Union	Code	Price £
1" x 1"	KMAU4MF	2.70
1½" x 1½"	KMAU6MF	15.00



Cross Piece	Code	Price £
1" x 1" x 1" x 1"	KMAX4	6.90



Union	Code	Price £
1" x 1"	KMAU4	4.00



Nipple	Code	Price £
1" x 1"	KMAN4	1.80
1" x ¾"	KMAN4-3	1.90



Manifold 1"	Code	Price £
2 Way	KMAM2	11.00
3 Way	KMAM3	16.00

Water Meters



All water meters come with threaded tail pieces to allow removal. Install horizontally. Metal body 16 bar pressure rated. Dial indication 1L – 10,000m³.

Need to know how much water you are applying? Fit a water meter and keep a check on the readings.

Size	Max Flow	Nominal Flow	Code	Price £
¾" M	5 m ³ /h	2.5 m ³ /h	EWMA3	146.00
1" M	10 m ³ /h	5 m ³ /h	EWMA4~	210.00

PTFE Tape



Gas quality – i.e. very thick and you don't need much. Don't waste money on the normal thin type!

Code	Price £
EPTFE-G	2.10

Pressure Gauge



Option of either 63mm liquid filled gauge or 50mm plastic dry gauge. ¼" BSPM thread

Type	Range	Code	Price £
Stainless	0 - 10 bar	EPG-10B	16.00
Plastic	0 - 7 bar	EPG-07B	8.00

Pressure Test Kit



Ideal for pressure testing water supplies.

Code	Price £
EPTST	15.00

Tool Kit



The complete starter set for installing irrigation systems. Includes tool box, chamfering tool, pipe cutters and 'C' spanner.

Pipe Cutters
For pipe up to 32mm



Chamfering Tool
For pipe 16mm - 63mm. Bevel ends of pipe for easier fitting.



'C' Spanner
For fittings up to 40mm



	Code	Price £
Kit	KHTK	67.00
Cutters	FLCUT	17.00
Chamfer	FLCHAM	27.00
'C' Spanner	FLSP	18.00

Warning Label



Adhesive warning label suitable for outdoor use. Required on taps, tanks and valve boxes. 125mm x 30mm.

Code	Price £
FLWL	0.70

Saddle Hole Cutter



Ideal for cutting holes for saddles. Fit saddle before cutting hole. 15mm hole size.

Code	Price £
FLSAD	44.00

Threaded Valves and Taps

Ball Valve



PVC single or double plastic unions.
Full bore ball valve.

VDL		
F	Code	Price £
½"	EVLUT2	17.00
¾"	EVLUT3	22.00
1"	EVLUT4	27.00
1½"	EVLUT6	42.00
2"	EVLUT8	65.00

Gate Valve



Brass. More frost resistant than a ball valve. More controllable flow.

F	Code	Price £
¾"	EVG3	16.00
1"	EVG4	23.00
1½"	EVG6	37.00
2"	EVG8	57.00

Check Valve & Strainer



Brass. Conical seating, not a cheap leaky flap.

	F	Code	Price £
Check Valve	¾"	EVC3	17.00
	1"	EVC4	23.00
	1½"	EVC6	51.00
Check Valve with strainer	1"	EVFS4	35.00
	1½"	EVFS6	62.00
Strainer only	1"	EVS4	5.00

Stopcock



Conforms to Water Regulations when used above ground. See p42 for below ground stop cocks.

F	Code	Price £
½"	EVSC2	19.00
¾"	EVSC3	35.00

Lever Valve



Brass. Full bore ball valve allows maximum flow.

F	Code	Price £
½"	EVL2	15.00
¾"	EVL3	24.00
1"	EVL4	29.00

Ice Valve



Frost resistant to -20°C. Ideal for outdoor taps.

Inlet	Outlet	Code	Price £
½"	¾"	EVFV2	29.00
¾"	1"	EVFV3	41.00

Double Check Valve



Brass. Complies with water regulations.

F	Code	Price £
½"	EVCV2	50.00
¾"	EVCV3	58.00

Wall Plate



Wall plate with built-in compression fitting.

mm-F		Code	Price £
15mm Conex x ½"	Brass	EW15-2	5.40
20mm MDPE x ½"	Plastic	EW20-2	16.00
25mm MDPE x ¾"	Plastic	EW25-3	17.00

For warning label see page 44.

½" Bib Tap



½" M inlet, ½" hose union outlet. Built in check valve to comply with water regulations. ¾" M threaded outlet accepts quick connectors or 'Geka'.

	Code	Price £
With Double Check Valve	ETBC2	19.00
Without Double Check Valve	ETB2	14.00

¾" Bib Tap



¾" M inlet, ¾" hose union outlet. Designed for higher flows. 7/8" M threaded outlet accepts 'Geka' 7/8" F adaptor FGBF78. FCT13-78 adapter converts 7/8" thread to ¾" male thread.

Code	Price £
ETB3	44.00
FGBF78	5.30
FCT13-78	22.00

Quick Coupling Valve and Take Off

Quick couplings are ideal for garden centres and landscape areas. Fit the valve in the ground, then whenever you wish to water, plug in the take-off, and you will be supplied with water automatically. The water shuts off again when the take-off is removed.

Valve: Plastic – hinged cap. ¾" M

Take off: Plastic – ¾" M



	M	Code	Price £
Valve	¾"	EVQC	12.00
Take-off	¾"	EVQCTO	5.80

uPVC Pipe and Fittings-Metric

uPVC Pipe

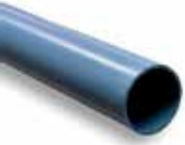

mm	10 Bar	Price £
20	PM20-1M	5.80
20	PM20-1.25M	6.70
25	PM25-2M	10.00
32	PM32-2M	8.80
50	PM50-2M	16.00

Drain Valve



		Code	Price £
32mm 1 1/4" F	With Elbow	FMDVE32	6.60

Elbow 90°



**Genuine
VDL
Fittings**

mm	Code	Price £
20	FME20	1.20
25	FME25	1.30
32	FME32	1.40

Connector



All of the FMK connectors (except for FMK20-3) will fit inside a fitting one size larger. i.e. FMK25-3 will fit into a FMT32 tee.

mm	Code	Price £
20 - 3/4" M	FMK20-3	1.10
25 - 3/4" M	FMK25-3	1.10
25 - 1" M	FMK25-4	1.10
32 - 3/4" M	FMK32-3	1.10
32 - 1" M	FMK32-4	1.10
50 - 1" M	FMK50-4	2.80
50 - 1 1/2" M	FMK50-6	2.80

Socket



mm	Code	Price £
20	FMS20	0.80
25	FMS25	0.80
32	FMS32	0.90
50	FMS50	1.70

Socket x F



mm	Code	Price £
20 - 1/2" F	FMS20-2F	1.80
25 - 3/4" F	FMS25-3F	2.20
32 - 1" F	FMS32-4F	3.60
50 - 1 1/2" F	FMS50-6F	5.00

Tee x M, x F



mm		Code	Price £
20 - 1/2" F	Female Branch	FMT20-2F	2.70
25 - 3/4" F		FMT25-3F	3.10
32 - 1" F		FMT32-4F	3.90
32 - 1 1/4" M	Male Branch	FMT32-5	1.70

Drilled Pipe

mm	Length	Holes	Code	Price £
25	2m	1 x 7/16"	PM25-2A	11.00

For 7/16" adaptors see L04 p47

Valve



mm	Code	Price £
20	EVLU20	12.00
25	EVLU25	15.00
32	EVLU32	18.00
50	EVLU50	27.00

Elbow x F



Glued x 1" Female

mm	Code	Price £
32	FME32-4F	3.40

Filter Pack



1" F x 1" M

mm	Code	Price £
32	LUPF	28.00

Cap & Washer



VDL or PALAPLAST

F	Code	Price £
1/2" F	FMC2	1.40
3/4" F	FMC3	1.30
1" F	FMC4	1.80
1 1/2" F	FMC6	2.30
2" F	FMC8	5.00

Socket (Metric to Imperial)



	Code	Price £
25-3/4"	FMS25/3	0.90
32-1"	FMS32/4	1.00

Tee



mm	Code	Price £
20	FMT20	1.50
25	FMT25	1.50
32	FMT32	1.40
50	FMT50	3.20

Reducing Bush



mm	Code	Price £
25 - 20	FMR25-20	1.00
32 - 25	FMR32-25	1.00
50 - 32	FMR50-32	1.90

We use VDL fittings - acknowledged to be the best. Repairing joints can be a nightmare without VDL.

Union



mm	Code	Price £
20	FMU20	4.50
25	FMU25	5.60
32	FMU32	6.90
50	FMU50	8.10

Union x M



mm	Code	Price £
25 - 3/4" M	FMU25-3	6.30
32 - 1" M	FMU32-4	7.80
50 - 1 1/2" M	FMU50-6	9.30

Miscellaneous Fittings

Glue and Brush*



Data sheet available

	Type	Code	Price £
125ml	UNI	FMCEM100	12.00
250ml	S3	FMCEM250	26.00

Cleaner



Data sheet available.

Always use pipe cleaner on joints prior to gluing.

	Code	Price £
250ml	FMCLC250	15.00

Galvanised Wire



Weight/Approx Length	Code	Price £
0.5kg 30M/100'	ESW-0.5K	6.80
2.5kg 64M/210'	ESW-2.5K	31.00

Wire Strainer



Nº 2 size.

Code	Price £
ESW	3.20

Ratchet Strap Black Nylon



Helpful Selection Guide									
Pipe size to wire mm	Pipe size to 32mm ridge	Pipe size to 63mm ridge	Max diameter circle mm	Useable length mm	Width mm	25 pack	Price £	100 pack	Price £
20			23	75	2.4			FPC100-H	2.00
25 & 32			35	110	3.6	FPC150-Q	2.50	FPC150-H	4.40
40	25		50	172	3.6	FPC200-Q	3.20	FPC200-H	7.10
	32	25 & 32	60	270	4.8	FPC300-Q	4.30	FPC300-H	11.00

Adaptor for Drilled Pipe



L04: KEPW adaptor and KCWR ring drill 7/16" (11mm) hole in uPVC, or use pre-drilled pipe.

Takes downtubes or 6mm sprinklers.

Qty	Code	Price £
10	L04-T	6.50
100	L04-H	52.00

Downtube Weight



Qty	Code	Price £
10	L-WT-T	5.80
100	L-WT-H	45.00

Drip-Stop Valve



1.1 bar opening pressure. 6mm F x 6mm M. Can be used either way round.

Qty	Code	Price £
10	KENV-T	12.00
100	KENV-H	110.00

Downtubes

Downtube, weight, collar, plunger. Collar fits L04, or KEPW, KEPM adaptor.

Bottom plunger takes 6mm M sprinklers.

Length	Qty	Code	Price £
0.3m	10	L41-0.3-T	9.00

Downtubing



Extra Flexible

Plain tube 6.8 x 4mm flexible PVC.

Length	Code	Price £
100m	P59-100M	79.00

Sports

Irrigation is vital if surfaces are to be kept green and playable. As well as a wide range of sprinklers and controllers, we can advise on water storage, pumps and supply pipework. These pages contain a sample of the products we offer – a wider range of products, and full data sheets are available online.



Hunter I-40

DATA SHEET ONLINE



The worlds No 1 sprinkler for sports, the I-40 is tough and reliable

- Radius: 13.4m - 21.6m
- Flow Rate: 1.52 - 6.55m³/hr
- Pressure: 2.5 - 6.5 bar
- Popup height: 4"

1" BSPF thread

	Code ~	Price £
I-40 adjustable	KHP40	118.00
Box of 10 adjustable	KHP40BX	1040.00
8" swing joint 1" x 1"	KHSJ8-4	61.00

Nozzle	Bars	Radius	m ³ /hr
40	4.5	14.0m	2.03
41	5.0	15.8m	2.79
42	5.0	16.8m	3.01
43	5.0	18.0m	3.75
44	6.0	20.1m	5.56
45	6.0	21.3m	6.28

Performance data for I-40 adjustable

Rainbird 952E

DATA SHEET ONLINE



Multi-jet sprinkler for Bowling Greens and Golf courses. Valve in head design.

- Radius: 21.9m – 27.4m
- Flow Rate: 5.22 – 9.20m³/hr
- Pressure: 4.1 – 6.9 bar
- Full circle plus 30°-345° arc
- Popup height: 6cm
- 12" swing joint 1½" BSPF Thread

	Code ~	Price £
952E with #46 nozzle	KB950E	740.00

Nozzle	Bars	Radius	m ³ /hr
20	4.1	21.3m	4.50
20	6.9	22.6m	5.70
22	4.1	22.5m	5.20
22	6.9	23.7m	6.90
24	4.1	22.3m	6.20
24	6.9	25.0m	8.00

Carson Valve Box

DATA SHEET ONLINE

Heavier duty Valve Boxes for Sports Fields.

	Box	Price £	Spare Lid	Price £	Metal Cover ~	Price £
10" Round	KHC10	29.00	KHC10LID	11.00		
Standard	KHCSTD	64.00	KHCSTDLID	25.00	KHCSTDLM	282.00
Jumbo	KHCJMB	88.00	KHCJMBLID	35.00	KHCJMBLM	333.00



Irritec Valve Boxes

Imperial Size	Lid Diameter	Base Diameter	Height	Code	Price £	Spare Lid	Price £
10" round	23cm	30cm	25cm	KHB10	16.00	KHB10LID	6.30
12" x 18" Standard	38 x 25cm	47 x 33cm	30cm	KHB1218	37.00	KHB1218LID	18.00
12" x 22" Jumbo	50 x 34cm	60 x 45cm	30cm	KHB1420	56.00	KHB1420LID	30.00



For warning label see page 44.

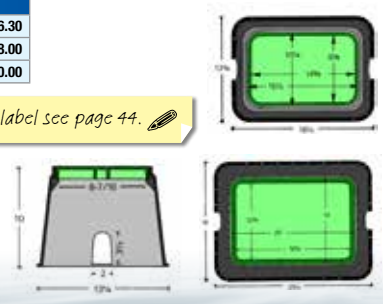

NEW

Bowling Green Package

Fully automated watering for a top quality surface

For the best results with the minimum of effort an automated popup sprinkler system can be installed. This package includes 4 popup sprinklers, each one located half way down the side of the green, pipework that is located in the roll off gutter and a pump, tank and automatic controller. A rain sensor is also included to reduce watering costs.

A full specification and layout plan is available on our website.

What you get

- 5,000 litre irrigation storage tank with mains water connection and Water Regulation compliance kit
- Multi-stage stainless steel pump with autostart, pre-assembled and tested
- Irrigation controller with rain sensor
- Pipework from pump to green with necessary fittings
- 4 Popup sprinklers



Area	Code ~	Price £
40m x 30m	SB1G32-43	9160.00
40m x 40m	SB1G32-5K	10060.00

Manège Package

NEW

Automated dust suppression

Large sprinklers are located around the perimeter fencing, throwing water into the manège. Includes pipework and a pump and storage tank. An automatic controller will bring the irrigation system on early in the morning to water the manège, keeping dust levels down. A full specification and layout plan is available on our website.

What you get

- Large tank to comply with the Water Regulations
- Single phase pump unit to provide the appropriate pressure
- Pipework and valve boxes for perimeter watering
- Automatic controller with the option of wi-fi connectivity



Area	Code ~	Price £
20m x 40m	SMP24	5800.00
20m x 60m	SMP26	7180.00
30m x 60m	SMP36	8430.00

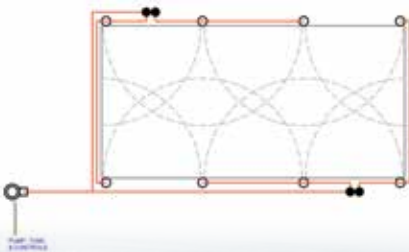

~ see p52

DATA SHEET ONLINE

Sports Pitch Strip Sprinkler Package

A low cost method of watering a complete football or Rugby pitch in 10 days using a standard water supply.

Two options are available, for grounds where the pressure and flow are good the system can be run directly from the mains water supply; for faster watering or for poorer supplies a pumped system is available.

The package consists of temporary sprinklers run across the width of the pitch.

The pumped system also includes an underground pipe to run down one side line with 5 take-off points.



	Code ~	Price £
Mains	STPW6	3990.00
Pumped	STPW-P	7610.00

What you get (mains)

- 6 sprinkler sleds to cover pitch width
- Connecting hose and 2 hose reel carriers
- 2-zone battery controller to water 3 sprinklers at a time

What you get (pumped)

- 7 sprinkler sleds to cover pitch width
- Connecting hose and hose reel carrier
- 5 take-off points and 150m underground pipe

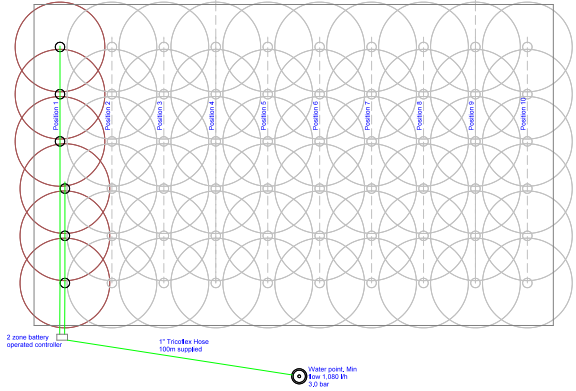

Reel Irrigators

DATA SHEET ONLINE

Reel irrigators are designed to water large grass surfaces such as playing fields or football or rugby pitches. Units will require a water storage tank and pump to provide enough pressure. Reel irrigators incorporate a drum of hose which is unwound manually. Once the irrigator is operating, the hose will automatically be pulled along the grass until it returns to the unit.

Speedy Rain 32/90

Hose diameter x length: 32mm x 90m

Output range: 1.68 – 3.60 m³/hr

Connection pressure: 3.5 – 5.0 bar

Wetted width: 26 – 37m

Rewind speed: 10 – 30 meters / hour

Code ~	Price £
EHR132	3850.00



Speedy Rain 40/130

Hose diameter x length: 40mm x 130m

Output range: 2.94 – 7.44 m³/hr

Connection pressure: 4.4 – 8.0 bar

Wetted width: 26 – 44m

Rewind speed: 10 – 40 meters / hour

Code ~	Price £
EHR140	7350.00



~ see p52

Order Information

Terms and Conditions

These Terms of Business are in addition to our Terms and Conditions of Sale. All orders placed with Access are subject to our Terms and Conditions of Sale unless agreed in writing by a director of Access Irrigation Ltd. A full copy of the Terms and Conditions of Sale is available on request.

Placing your Order

Please indicate the quantities, reference code and description on all orders. Please also include a contact phone number.

Phone: 01788 823811

We are open Monday - Friday 8.30am - 5.00pm or leave a message outside office hours.

Email: sales@access-irrigation.co.uk

A convenient way to order, 24 hours a day.

Online: www.access-irrigation.co.uk

All components are listed online for fast and easy ordering.

Collection

For a speedy service, phone your order through beforehand.

Payment Terms

New Customers

We require payment with order.

Existing Customers

Existing customers may open a credit account - details are available on request.

We accept payment by

Cheque, or the following credit and debit cards.



Damaged Goods

Any goods delivered damaged must be signed for as damaged and notified to us in writing, within 5 days; otherwise no claims can be accepted.

E&OE: Access reserve the right to change products and prices at any time. No part of this Catalogue may be reproduced by any method without prior permission from Access Irrigation Ltd.

FREE Economy Delivery

Catalogue orders over £125 (ex VAT) will be despatched by post or carrier free of charge if paid by credit / debit card.

This service will normally take 3 – 5 working days longer than the Standard service. The order will generally be held until all items are ready for despatch.

Direct despatch (~) items and bulky/high value items are excluded.

STANDARD Delivery

Our standard service ensures that orders are normally despatched within 48 hours (over 85% are despatched in 24 hours). Items are despatched using fully traceable 24hr carriers.

Delivery charges for orders paid for by credit/debit card:

£0 - £250 **£15.95**

£250 + **£24.95**

For a faster service, orders will be part despatched if any items are out of stock.

Direct despatch (~), special order (+), heavy and bulky items may take longer and may attract a surcharge.

Pallet deliveries: items marked ++ are built to order and will be despatched on a pallet at additional cost.

NEXT DAY Delivery

For really urgent orders, we can arrange for a next day delivery service for items in stock. Please ring through your order to check the stock situation. A delivery surcharge will apply.

Other Terms

Deliveries to remote areas (eg. Scottish highlands), Northern Ireland, Eire and non-mainland addresses will be charged at cost.

Orders under £125

For non-priority orders under £125, paid by credit / debit card, the following charges apply:

Under 1kg 1st class post **£4.95**

Over 1kg Economy carrier **£9.95**

Special Terms

Items marked + or ++ in the catalogue will be made/ purchased to order, and may take a little longer to despatch. Items marked ~ are purchased to order so orders with these items may take a little longer to despatch.

A		Filters	36	O		Speedy rain	51
Air gap tank	36	Flexidrip	5	Ottima	5	Spiked riser	11,13
Amber mist nozzle	9	Floating level switch	31	Overhead irrigation	3	Sports	48-51
Anchorage pegs	20	G		P		Spray gun	14
B		Galconette battery controller	28	Part circle sprinkler	12	Sprinkler heads	10,12
Bag dilutor	2	Gate valve	45	Permadrip	21	Sprinklers	10-13
Ball valve	45	'Geka' hose fittings	14-15	Pin plugs	40	Stake risers	11,13,18,19
Ball valve and float	36	Glue (uPVC)	47	Pipe & Fittings	37-47	Stock bed watering kit	6
Barbed fittings	41	Grease filled connectors	31	Pipe (Polythene)	40	Stopcock	42,45
Barbed valve	41	Greenhouse watering	3	Pipe (uPVC)	46	Strainer	45
Battery operated controller	28	H		Pipe cleaner (uPVC)	47	Straining wire	47
Bayonet hose connectors	14	Half circle sprinkler	10	Pipe clips	40	Submersible pumps	33
Bedding spike	11	Hand Watering	14-17	Pipe cutters	44	Suction hose	33
Bermad solenoid valve	30	Hanging basket feeder	27	Pipe marking tape	40	Swing joints	25
Bib tap	45	Hanging basket watering	26-27	Pipe saddles	42	T	
Blanking plug	38	Heavy duty hose reel	16	Plasim fittings	42	Tall bedding spike	11
Bluetooth controller	28	Heron panel	30	Plastic water tanks	35	Tanks	35
Border link kit	23	Hose clips	15	Polyphosphate filter	9	Tank connector	36
Border watering kit (drip)	23	Hose couplers	15	Polythene pipe	40	Tank fittings	36
Border watering kit (sprinkler)	18-19	Hose hanger	16	Polythene tanks	35	Tank pump	34
Bore hole pumps	34	Hose pipe	15	Pop-up sprinklers	24,25,49	Taps	45
Bowling green package	49	Hose reels	16	Portable hose reel	16	Tap timer	28
Brass quick connectors	17	Humidity sensor	30	Portzlock fittings	43	Tape-PTFE	44
C		Hunter controllers	29	Pre-assembled pump unit	35	Tape-Trickle	6
'C' spanner	44	Hunter pop-up sprinklers	24-25,48	Pressure booster set	34	Temporary lawn watering	22
Cable	31	Hunter shrub sprinkler	11	Pressure compensated drip line	21	Threaded fittings	39
Cable tie	47	Hunter solenoid valve	30	Pressure compensated dripper	4	Threaded valves	45
Cap and washer	39,42	I		Pressure gauge	44	Toolkit	44
Carson valve boxes	48	Ice valve	45	Pressure regulator	36	Travelling sprinkler	50
Chamfering tool	44	J		Pressure vessels	31	Tree watering dripper	5
Check valve	45	Jubilee Clips	15	Professional lance	14	Trickle tape	6
Cleaner-pipe	47	L		PTFE tape	44	Tricoflex hose	15
Clip-pipe	40	Lances	14	Pump starter boxes	33,35	T-tape & fittings	6
Coils (solenoid)	30	Landscape Watering	18-27	Pumps	32-36	Tunnel watering	3
Compression fittings	42	Large spiked riser	13	Punches	4,7	U	
Contractor hanging basket kits	27	Lawn kit	22	Q		Underground valves	45
Control Systems	28-31	Level switch	31	Quick coupling valve	45	Union fittings	45,47
D		Lever valve	45	Quick hose couplings	15,17	uPVC pipe & fittings	46-47
DB Valve	27	Light sensor	30	R		V	
Decoder cable	31	Liquid Feeding	2-3	Rain sensor	29,30	Valve-ball	45,46
Decoders	29	Low voltage cable	31	Rain train	50	Valve-barbed	41
Dilutors	2	M		Rainbird sprinkler	49	Valve-boxes	23,48
Disc filters	36	Maclow clips	40	Ratchet strap	47	Valves	45
Double check valve	45	Mains operated controller	29,30	Reel irrigator	51	Vibro-spin sprinkler	10
Downtubes	47	Manifold fittings	43	Rega travelling sprinkler	50	W	
Downtube weight	47	Manifold taps	17,23	Repair Plug	38	Wall mounted hose reel	16
Drain valve	46	MDPE pipe	40	Risers	11,13	Wall plate	45
Drip lines	20-21	Menage package	49	Roses	14	Warning label	44
Drip tape	6	Mini click sensor	29	Rotator sprinklers	24	Water meter	44
Dripper kit	20	Mini mist nozzle	10	S		Water pipe	40
Dripper lead	4	Mini tap	38	Saddles	42	Water storage pump	33
Dripper with shutoff	4	Mini-spin sprinkler	10	Saddle hole cutter	44	Weather station	30
Drippers	4	Mist nozzle	9	Screen filters	36	Well pumps	33
Drip-stop valve	47	Mist Propagation	8-9	Semi-automatic filter	36	Wet leaf	9
E		Mist-wean controller	8	Shrub head sprinklers	11	Wet leaf controller	8
Eindor fittings	38	MP Rotator	24	Signal cable	31	Wet leaf interface	30
Eindor sprinklers	10	N		Sled riser	13	Wi-Fi controller	29
Espa pumps	32	Naan sprinklers	12	Snap on hose connector	17	Wire & strainer	47
F		Netafim drippers	4	Softtrain lance	14	Y	
Field sprinkler	12	Nozzle adjustment key	24-25	Soil stake	20	'Y' piece	15
Field tape	6	Nursery Watering	3-7	Solenoid valves	9,28,30	Yellow hose	15

Access Irrigation Ltd, Crick, Northampton, NN6 7XS UK

Phone: 01788 823811

E-mail: sales@access-irrigation.co.uk

Web: www.access-irrigation.co.uk
